

Prestige

MK2

Installation, Operating and Servicing Instructions

Prestige Solo	24 - 32
Prestige AquaSpeed	24 - 32
Prestige Excellence	24 - 32



INDEX

WARNING	3
Who should read these instructions	3
Symbols	3
Recommendations	3
Applicable standards	3
Warnings	3
INTRODUCTION	4
Description of the specifications	4
USERS GUIDE	6
Directions for use	6
Settings the parameters	6
TECHNICAL CHARACTERISTICS	7
Natural gas model	8
Propane model	8
Natural gas categories	9
Propane categories	9
Diagrams of the pressure drops	9
Domestic hot water features	9
INSTALLATION INSTRUCTIONS	10
Dimensions	10
Boiler room	10
Wall mounting of the boiler	10
Distances of hydraulic connections	11
INSTALLATION	12
Connection to the chimney	12
Domestic hot water connection : Prestige Solo	13
Domestic hot water connection : Prestige AquaSpeed / Excellence	14
Connection to the gas	14
Heating connections	15
Installation of simple heating circuit controlled by room thermostat ACV 15	16
Installation of simple heating circuit controlled by Room Unit	17
Installation of two heating circuits controlled by room thermostat ACV 15 and AM3-11 module	18
Installation of two heating circuits controlled by Room Unit and ZMC-1 module	20
ELECTRICAL CONNECTION	22
Wiring diagram : Prestige Solo / AquaSpeed / Excellence	22
COMMISSIONING AND MAINTENANCE	23
Commissioning the system	23
Inspection and maintenance	23
Disassembling the burner	24
Disassembling and checking the electrode	24
Disassembling the heat exchanger	24
AquaSpeed : Disassembling the inverted tank	24
Cleaning the heat exchanger	24
Temperature sensor resistance tables	24
MCBA PARAMETERS FOR THE SPECIALIST	25
Standby Mode	25
Settings the MCBA parameters	26
Request for information on the installation	27
Entering the code	27
MCBA parameters with code restricted access	28
Communication Mode	32
Error Mode	32
Safety stop + resolution of the fault	33
SPARE PARTS	

See at the end of this manual

WARNINGS

WHO SHOULD READ THESE INSTRUCTIONS

These instructions should be read by:

- the specifying engineer
- the installer
- the user
- the service engineer

SYMBOLS

The following symbols are used in this manual:



Essential instruction for the correct operation of the installation.



Essential instruction for the safety of persons and the environment.



Danger of electrocution.



Danger of burns

RECOMMENDATIONS



- Please, read carefully this manual before installing and commissioning the boiler.
- It is prohibited to carry out any modifications to the inside of the appliance without the manufacturer's prior and written agreement.
- The product must be installed and serviced by trained engineers, in compliance with current standards.
- Any failure to follow instructions relating to tests and test procedures may result in personal injury or risks of pollution.
- To guarantee safe and correct operation of the appliance, it is important to have it serviced and maintained every year by an approved installer or maintenance company.
- In case of anomaly, please call your service engineer.
- Despite the strict quality standards imposed by ACV during the manufacture, inspection and transport of its appliances, you might notice some errors. Please report immediately any fault to your approved installer. Remember to note the fault code displayed on the screen.

- The parts may only be replaced by genuine factory parts. You will find a list of the spare parts and their reference number ACV to the end of this document.
- The burners are preset in our factory for use with natural gas [equivalent to G20].
- An ajustement of the CO2 is not allowed in Belgium I 2E(s)B.



- It is important to switch the boiler off before carrying out any work.
- There are no user accessible parts inside the boiler casing.

APPLICABLE STANDARDS

The appliances carry the CE mark in accordance with the standards in force in the various countries (European Directives 92/42/EC "Efficiency", 90/396/EC "Gas appliances"). They also carry the "HR-TOP" label (Gas condensation boilers).



WARNINGS

IF YOU SMELL GAS:

- Immediately shut off the gas intake
- Open windows for fresh air flowing
- Do not use any electrical appliances and do not actuate any switches
- Immediately notify your gas supplier and/or your installer

This documentation is part of the information delivered with the appliance and must be given to the user and stored in a safe place!

An approved installer must carry out the assembly, commissioning, maintenance and repair of the system, in accordance with current standards in force.

ACV shall not accept any responsibility for damage caused by non-compliant location of the system or by use of the parts or connections not approved by ACV for this application.



The manufacturer reserves the right to change the technical characteristics and specification of its products without notice.



The availability of some versions and their accessories is market dependant.

INTRODUCTION

DESCRIPTION OF THE SPECIFICATIONS

The Prestige is a wall-mounted condensing boiler meeting the requirements of the HR-Top applicable standards force in Belgium. The boiler is certified compliant with EC standards as a connected appliance C13(x), C33(x), C43(x), C53, C83(x), but it can also be connected as an open appliance in category B23.

LINING

The boiler is protected by a steel lining that first of all undergoes a degreasing and phosphation process before being lacquered and heated at 220°C. The inside of this lining is coated with a layer of thermal and acoustic insulation, reducing losses to a minimum.

HEAT EXCHANGER

The core of the **Prestige** features a new stainless steel heat exchanger. This piece of technology represents the fruit of exhaustive research and intensive laboratory testing. It reflects ACV's eighty years of experience in using stainless steel for heating and hot water functions. The particular geometry of the exchanger pipes is calculated to obtain a very large Reynolds number throughout its cycles.

The Prestige achieves an exceptional output that remains stable throughout the boiler's life, given that it causes no oxidation on the exchanger, which is manufactured entirely from quality steel.

BURNER

ACV uses its BG 2000-M burner for the Prestige: this is an air/gas premix burner providing safe and silent operation while limiting emissions (NOx and CO) to an incredibly low level. Although the ACV BG 2000-M boiler is very modern, it uses proven technology and is manufactured from standard spare parts that are easily available on the market.

TEMPERATURE REGULATION

The basic version of the **Prestige** is fitted with a microprocessor controlled regulator (MCBA) which takes over both the safety functions (ignition, monitoring the flame, limiting the temperature, etc.) and control of the boiler temperature. This MCBA also includes a weather-dependent regulator. All you need to do is connect the outdoor temperature sensor available as an option to the device. However, this regulator can also operate with a standard on/off room thermostat. In addition, with the combination of a weather-dependent regulator and a room thermostat, you can control the temperatures based on the weather with compensation for the indoor temperature.

There are four user adjustable parameters. By entering a special maintenance code, qualified installers can access several other parameters to adapt the boiler to special requirements. In principle, these parameters are factory set for all normal applications.

PRODUCTION OF HOT WATER

- **Prestige Solo:** is custom-designed to operate for heating only or in combination with the whole range of ACV water tanks. The SmartLine range is the number one choice for domestic applications. To simplify the installation of such a combination, ACV has designed a specific hot water connection kit, easy to be incorporated inside the casing.

- **Prestige AquaSpeed:** has a constant supply of hot water from its 6-litre tank that is directly and immediately available. It combines all the advantages of hot-water storage and immediate production: instant hot water, without the need for additional hot water storage. The Prestige 32 AquaSpeed provides 13.3 litres of hot water per minute at 40°C, instantly and without waste (ΔT 30°C). The AquaSpeed mini tank is made of stainless steel and the hot water is heated by means of a copper coil in the tank.

- **Prestige Excellence:** combines all the advantages of ACV's Tank-in-Tank systems with the comfort and space saving of a wall-mounted boiler: in a 63 cm wide casing, it includes a 62-litre stainless steel Tank-in-Tank. The Prestige 32 Excellence supplies 258 litres of water at a temperature of 40°C in 10 minutes: In addition to their exceptional hot water supply capability, the Prestige Excellence tank-in-tanks feature:

- **A solution for scale deposits:** thanks to the specially designed corrugations, the hot water tank expands and contracts during the heating cycle, preventing the formation of scale.

- **A guarantee against the risk of Legionellae Disease and bacteria:** the hot water tank is fully immersed in the primary circuit and the hot water is constantly kept at a temperature above 60°C.

- **Exceptional resistance against corrosion and aggression:** provided by the stainless steel.

FROST PROTECTION

The boiler is equipped with an integrated frost protection: as soon as the NTC1 flow temperature drops below 7°C, the system activates the central heating pump. As soon as the NTC1 flow temperature drops below 3°C, the system automatically ignites the burner until the temperature rises above 10°C. The pump continues to run for about 10 minutes.

If an outdoor temperature sensor is connected to the system, the pump is activated as soon as the outside temperature drops below the specified threshold.

To provide efficient protection for the whole system, all valves of the valves on the radiators and the convectors should be completely open.

INTRODUCTION

PRESTIGE AQUASPEED

Chimney connection
[concentric tubes Ø 80/125 mm]

Burner, premix and modulating

Heat exchanger, stainless steel

Pump, central heating

Flue tube

Tappot 6 litres
[not available on Prestige Solo]

Pump, Domestic Hot Water

Electrical panel
[The control boxes on the rear are optional]

Control panel

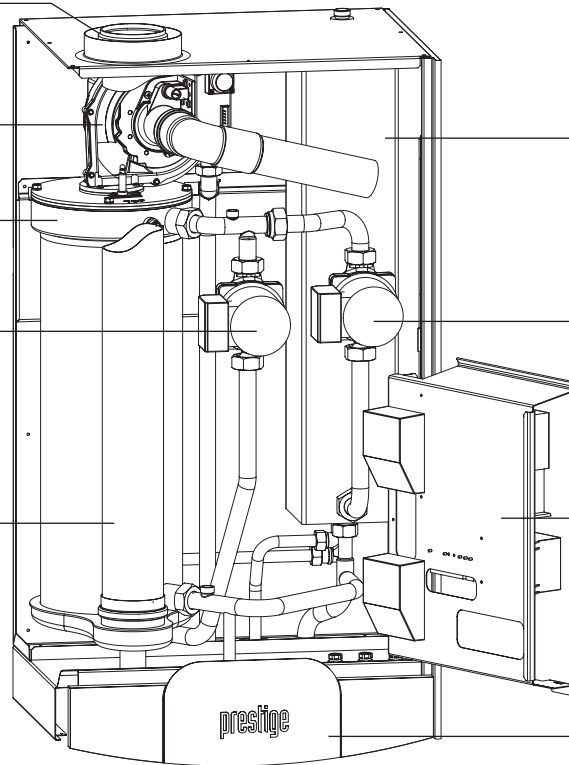

PRESTIGE EXCELLENCE

Flue tube
[concentric tubes Ø 80/125 mm]

Pump, Domestic Hot Water

Pump, central heating

Electrical panel
[The control boxes on the rear are optional]

Control panel

Burner, premix and modulating

Manual air vent

Water heater 62 litres

Heat exchanger, stainless steel

Hot water storage tank, stainless steel

Drywell for DHW sensor

Expansion vessel
[depend of countries]

Bracket for expansion vessel

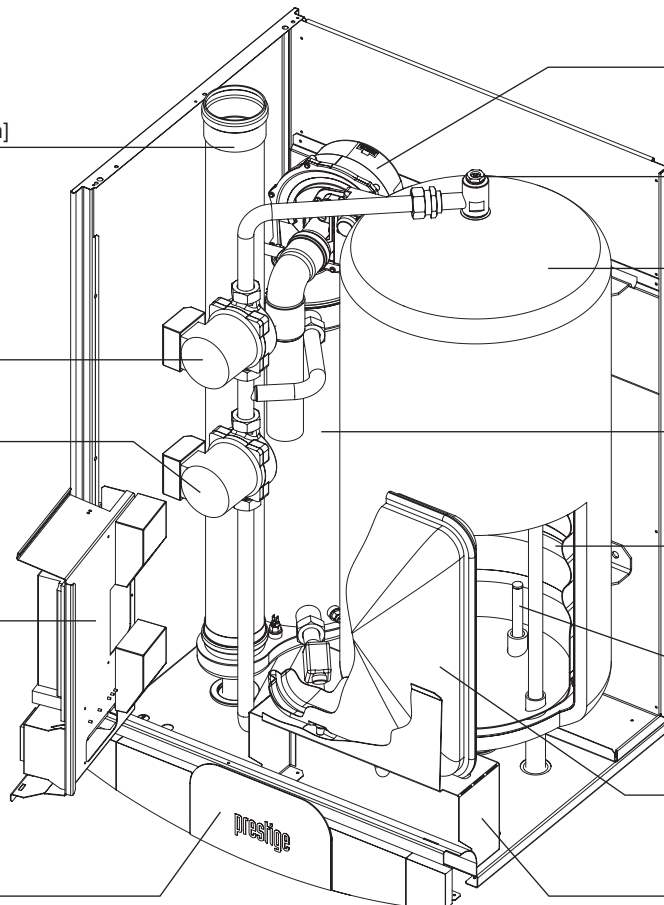

DIRECTIONS FOR USE

Your system must be checked once a year by an approved installer or maintenance company.

Starting the burner

During operation, the burner starts automatically as soon as the boiler temperature drops under the required set point and it stops as soon as the boiler reaches that temperature.

Control panel



Heating system

The central heating circuit must be pressurized (see in the chapter "Installation" how to define the system pressure).

The pressure indicator is located on the right-hand side of the display.



If your system needs to be refilled more than twice a year, please contact your installer.

The CH pressure must be a minimum of 1 bar and must be checked by the end user on a regular basis. If the pressure drops under 0.5 bar, the integrated water pressure switch blocks the appliance until the pressure in the system returns to a level above 0.8 bar. The connection for a fill valve is provided underneath the appliance. The installer can also fit the system with a separate valve. Make sure that the appliance is powered off when filling the system. To do this, toggle the Start/Stop switch located on the left of the screen to Off. (see the Control panel).

For more information, please ask your installer when the system is delivered.

A safety valve is provided at the underneath of the appliance. If the system pressure exceeds 3 bars, this valve opens and drains the water from the system. In this case, please contact your installer.

SETTING THE PARAMETERS



Also see the user label located inside the valve on the control panel:

Setting the domestic hot water temperature

(Hot water temperature)

- Press **Mode**: The screen displays **PARA**.
- Press **Step**: the first character is **1** and the last two characters give the current hot water temperature setting.
- To change this temperature, press + or - until the last two digits show the desired temperature value.
- Press **Store** to save the new temperature setting.
- Press **Mode** twice to return to Pilot mode (normal operating mode).

Enabling or disabling the hot water heating mode

(hot water)

- Press **Mode**: The screen displays **PARA**.
- Press **Step** twice: the first character is **2** and the last two characters give the current setting:
00 = disabled; **01** = enabled.
- To change this parameter, press + or - until the screen displays the desired value:
00 = disabled; **01** = enabled.
- Press **Store** to save.
- Press **Mode** twice to return to Pilot mode (normal operating mode).

Enabling or disabling Central Heating mode:

(heating)

- Press **Mode**: The screen displays **PARA**.
- Press **Step** three times: the first character is **3** and the last two characters give the current setting:
00 = disabled; **01** = enabled.
- To change this parameter, press + or - until the screen displays the desired value:
00 = disabled; **01** = enabled.
- Press **Store** to save.
- Press **Mode** twice to return to Pilot mode (normal operating mode).

Setting the central heating temperature:

(maximum temperature for the heating circuit)

- Press **Mode**: The screen displays **PARA**.
- Press **Step** four times: the first character is **4** and the last two characters give the current central heating temperature setting.
- To change this temperature, press + or - until the last two digits show the desired temperature value.
- Press **Store** to save the new temperature setting.
- Press **Mode** twice to return to Pilot mode (normal operating mode).

Fault:

The temperature setting for the appliance and the safety functions for its various parts are continuously monitored by a regulator controlled by a microprocessor (the MCBA). In the event of a fault, this MCBA disables the appliance and displays an error code: the screen flashes displaying **E** as the first character, followed by the error code.

To reset the appliance:

- Press **"Reset"** on the screen.
- Contact your installer if the fault happens again.

TECHNICAL CHARACTERISTICS

NATURAL GAS MODEL

Central heating		Solo		AquaSpeed		Excellence	
		24	32	24	32	24	32
Max. Input 80/60°C	kW	24	32	24	32	24	32
Min. Input 80/60°C	kW	5,9	5,9	5,9	5,9	5,9	5,9
Max. output 80/60°C	kW	23,4	31	23,4	31	23,4	31
Min. output 80/60°C	kW	5,8	5,8	5,8	5,8	5,8	5,8
Efficiency 30% load [EN677]	%	109	109	109	109	109	109

Flue gases

CO emissions max. / min. Input	mg/kWh	45 / 20	52 / 20	45 / 20	52 / 20	45 / 20	52 / 20
NOx emissions [EN483]	mg/kWh	66	66	66	66	66	66
NOx classification [EN483]		5	5	5	5	5	5
Flue gas temperature — max. Input 80/60°C	°C	70	76	70	76	70	76
Flue gas temperature — max. Input 50/30°C	°C	37	39	37	39	37	39
Mass flow rate of combustion products	kg/h	38	52	38	52	38	52
Flue gas pipe - Max. pressure drop	Pa	130	130	130	130	130	130
Concentric flue gas channel maximum length Ø 80 / 125 mm	m	20	20	20	20	20	20

Gas

Category [varies by country]		I 2E[S]B — I 2Er — I 2H — I 2ELL — I 2L — I 2E					
Gas pressure	mbar	20/25	20/25	20/25	20/25	20/25	20/25
G20 gas flow rate	m³/h	2,5	3,4	2,5	3,4	2,5	3,4
G25 gas flow rate	m³/h	3,0	3,9	3,0	3,9	3,0	3,9
CO ₂ max. Input G20/25 (with front panel closed)	% CO₂	9,3	9,3	9,3	9,3	9,3	9,3
CO ₂ max. Input G20/25 (with front panel open)	% CO₂	9,0	9,0	9,0	9,0	9,0	9,0
CO ₂ min. Input G20/25 (with front panel closed)	% CO₂	9,2	9,2	9,2	9,2	9,2	9,2

Hydraulic parameters

Max. operating temperature	°C	90	90	90	90	90	90
Boiler water capacity	L	8	8	14	14	16	16
Domestic hot water circuit capacity	L	-	-	0,9	0,9	54	54
Maximum operating pressure central heating	bar	3	3	3	3	3	3
Heat exchanger pressure drop [ΔT = 20°C]	mbar	131	210	131	210	131	210
Capacity of the expansion vessel (depend of countries)	L	-	-	-	-	12	12

Electrical connection

Class	IP	30	30	30	30	30	30
Supply voltage	V/Hz	230 / 50	230 / 50	230 / 50	230 / 50	230 / 50	230 / 50
Maximum absorbed electrical power	A	0,8	0,8	1,2	1,2	1,2	1,2

Weight empty	kg	48	48	63	63	92	92
--------------	-----------	----	----	----	----	----	----

TECHNICAL CHARACTERISTICS

PROPANE MODEL

Central heating		Solo P		AquaSpeed P		Excellence P	
		24	32	24	32	24	32
Max. Input 80/60°C	kW	24	30,5	24	30,5	24	30,5
Min. Input 80/60°C	kW	5,9	5,9	5,9	5,9	5,9	5,9
Max. output 80/60°C	kW	23,4	29,6	23,4	29,6	23,4	29,6
Min. output 80/60°C	kW	5,8	5,8	5,8	5,8	5,8	5,8
Efficiency 30% load [EN677]	%	109	109	109	109	109	109

Flue gases

Flue gas pipe - Max. pressure drop	Pa	130	130	130	130	130	130
Concentric flue gas channel maximum length Ø 80 / 125 mm	m	20	20	20	20	20	20

Gas

Category [varies by country]		I 3P					
Gas pressure	mbar	30 / 37 / 50					
G31 gas flow rate	m³/h	0,98	1,3	0,98	1,3	0,98	1,3
CO ₂ max. Input G31 <i>(with front panel closed)</i>	% CO₂	11	11	11	11	11	11
CO ₂ max. Input G31 <i>(with front panel open)</i>	% CO₂	10,7	10,7	10,7	10,7	10,7	10,7
CO ₂ max. Input G31 <i>(with front panel closed)</i>	% CO₂	10,9	10,9	10,9	10,9	10,9	10,9

Hydraulic parameters

Max. operating temperature	°C	90	90	90	90	90	90
Boiler water capacity	L	8	8	14	14	16	16
Domestic hot water circuit capacity	L	-	-	0,9	0,9	54	54
Maximum operating pressure central heating	bar	3	3	3	3	3	3
Heat exchanger pressure drop [ΔT = 20°C]	mbar	131	210	131	210	131	210
Capacity of the expansion vessel <i>(depend of countries)</i>	L	-	-	-	-	12	12

Electrical connection

Class	IP	30	30	30	30	30	30
Supply voltage	V/Hz	230 / 50	230 / 50	230 / 50	230 / 50	230 / 50	230 / 50
Maximum absorbed electrical power	A	0,8	0,8	1,2	1,2	1,2	1,2

Weight empty

	kg	48	48	63	63	92	92
--	-----------	----	----	----	----	----	----

TECHNICAL CHARACTERISTICS

Natural gas categories		BE	FR	NL	LU	DE	AT - CH - CZ - DK - ES - IT - FI UK - IE - PT - SE - GR - HU
I 2 E(S)B	G20 / 20 mbar – G25 / 25 mbar	●					
I 2 Er	G20 / 20 mbar – G25 / 25 mbar		●				
I 2 L	G25 / 25 mbar			●			
I 2 E	G20 / 20 mbar				●		
I 2 ELL	G20 / 20 mbar – G25 / 20 mbar					●	
I 2 H	G20 / 20 mbar						●

Propane categories		DK - NL - NO - IT	BE - CH - ES - FR - UK IE - PT - FI - SE - IT - GR	AT - CH - CZ - ES NL - DE - LU - HU
I 3 P	G31 / 30 mbar	●		
I 3 P	G31 / 37 mbar		●	
I 3 P	G31 / 50 mbar			●

DIAGRAMS OF PRESSURES DROPS

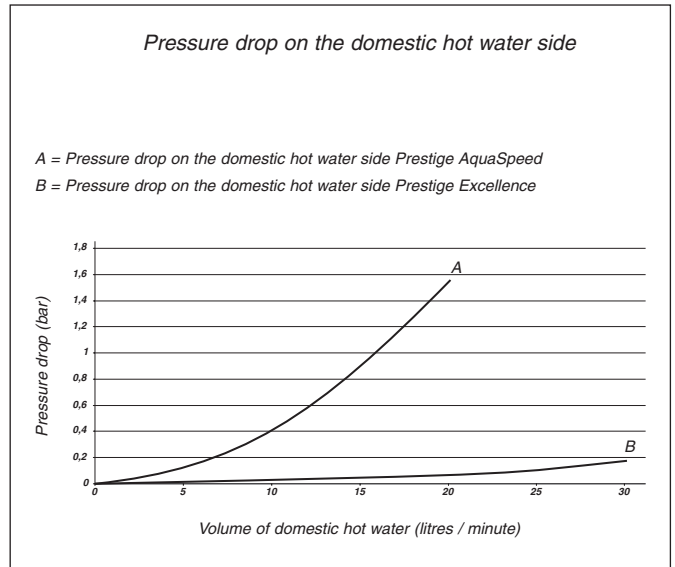
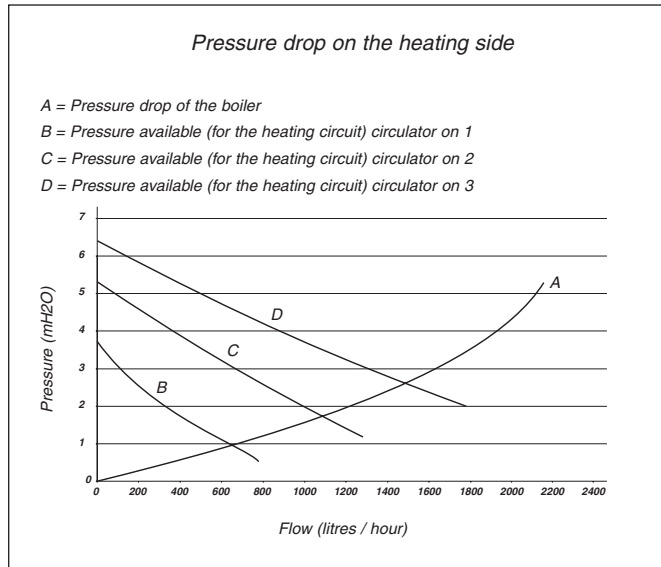

DOMESTIC HOT WATER FEATURES

Operating conditions at 80°C	AquaSpeed	
	24	32
Flow at 40°C [ΔT = 30°C]	L/min.	11 14,5
Flow at 60°C [ΔT = 50°C]	L/min.	6,6 8,3

Operating conditions at 80°C	Excellence	
	24	32
Peak flow at 40°C [ΔT = 30°C]	L/10'	175 224
Peak flow at 40°C [ΔT = 30°C]	L/60'	733 835
Constant flow at 40°C [ΔT = 30°C]	L/h	653 745
Peak flow at 60°C [ΔT = 50°C]	L/10'	102 103
Peak flow at 60°C [ΔT = 50°C]	L/60'	352 353
Constant flow at 60°C [ΔT = 50°C]	L/h	316 320
Pre-heat time	minutes	27 25

INSTALLATION INSTRUCTIONS

DIMENSIONS

	Solo / AquaSpeed	Excellence
A mm	970	1030
B mm	502	632
C mm	107	110
D mm	80	80
E mm	125	125
F mm	300	300
G mm	930	1000
H mm	400	535

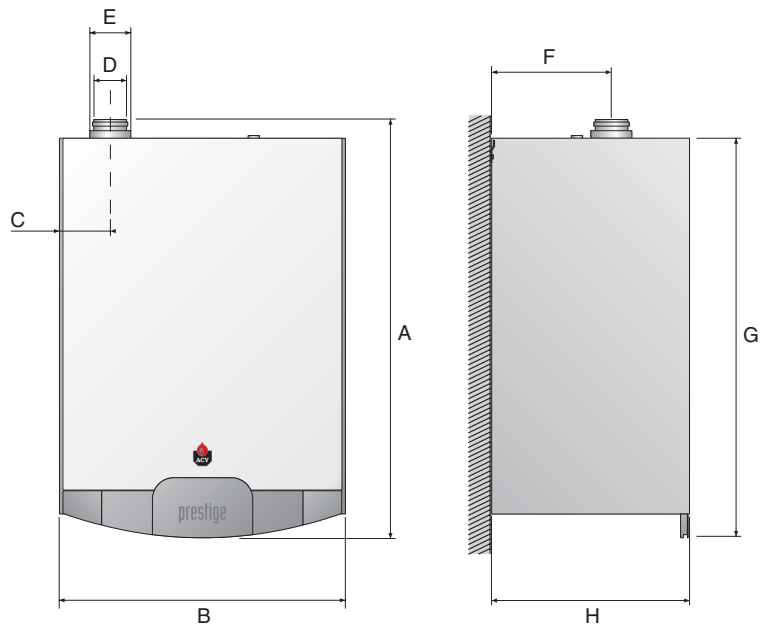

BOILER ROOM

- Make sure that all air vents are unobstructed any times.
- Do not store any flammable products in the boiler room.
- Do not store any corrosive products, paint, solvents, salts, chlorine products and other detergent products near the appliance.
- If you smell gas, do not switch on any lights, turn off the gas tap at the meter, ventilate the rooms and contact your installer.

ACCESSIBILITY

The appliance must be positioned in such a way to be accessible any time. In addition, the following distances are required around the appliance.

WALL MOUNTING OF THE BOILER

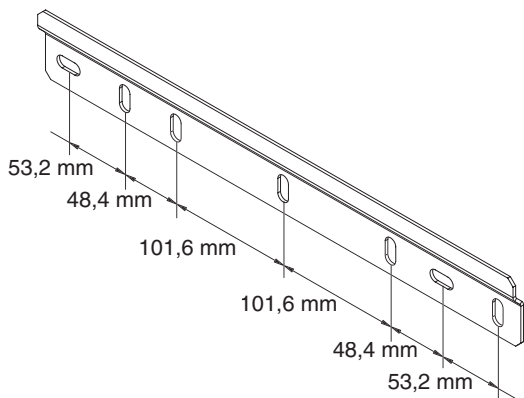

- The boiler must be mounted on a non-flammable wall.
- Drill two 10 mm diameter holes, spaced as indicated on the above drawing.
- Secure the wall-mount bracket with the delivered anchor screws.
- Hook the boiler on the bracket.

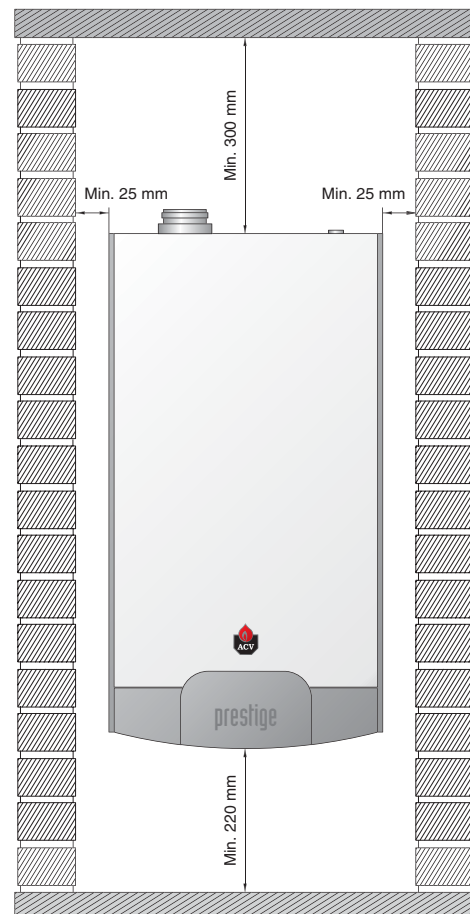

INSTALLATION INSTRUCTIONS

DISTANCES OF HYDRAULIC CONNECTIONS : SOLO

- A. CH supply 1" [F]
- B. CH return 1" [F]
- C. Supply to the water heater 1" [F] - *With Kit DHW 10800079*
- D. Return from the water heater 1" [F] - *with Kit DHW 10800079*
- E. Gas connection 3/4" [M]

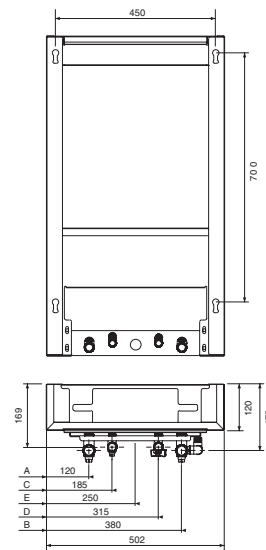
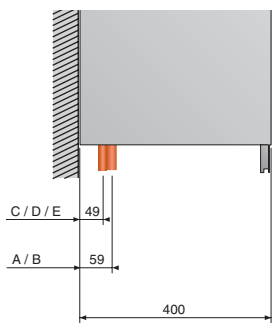
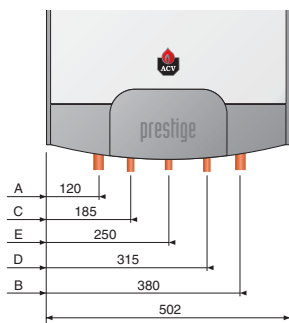

DISTANCES OF HYDRAULIC CONNECTIONS : AQUASPEED

- A. CH supply 1" [F]
- B. CH return 1" [F]
- C. Domestic hot water supply 1/2" [M]
- D. Cold water inlet 1/2" [M]
- E. Gas connection 3/4" [M]

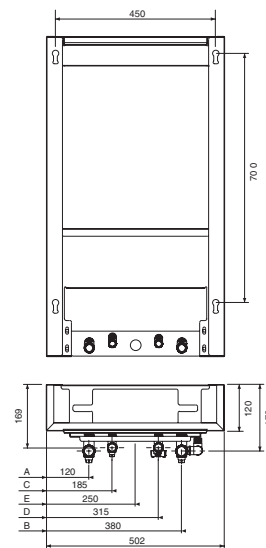
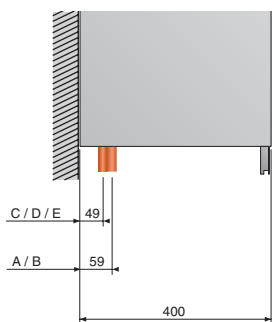
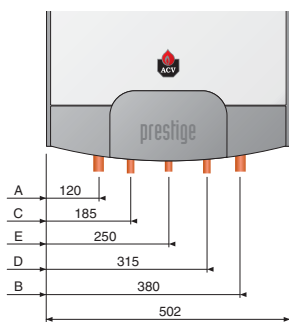

DISTANCES OF HYDRAULIC CONNECTIONS : EXCELLENCE

- A. CH supply 1" [F]
- B. CH return 1" [F]
- C. Domestic hot water supply 3/4" [M]
- D. Cold water inlet 3/4" [M]
- E. Gas connection 3/4" [M]

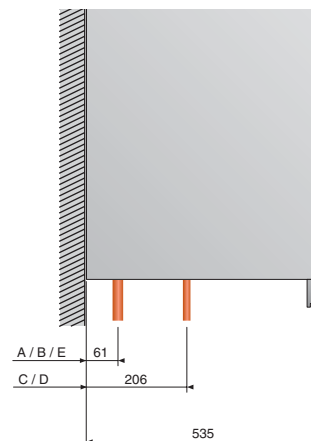
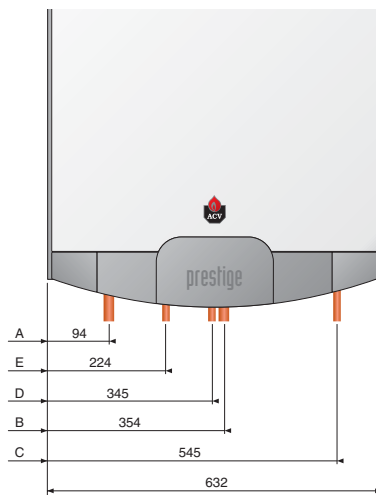

INSTALLATION

CONNECTION TO THE CHIMNEY

- The chimney connections must comply with the applicable standards (in Belgium: NBN D51-003), the local energy supplier's instructions, the fire regulation and neighbourhood good practices.
- The **Prestige** has an inbuilt gas/air ratio regulator, which makes it largely independent of the pressure drop in the air intake and flue gas extraction system. However, the maximum pressure drop for this system may not be exceeded, or the pressure will diminish. Nevertheless, the gas/air ratio regulator continuously guarantees optimum combustion with very low emission levels.
- The horizontal flue gas pipes must always be installed with a min. slope of 5 mm per meter, upwards from the boiler side.
- There must be no obstruction or openings for any other appliances within a radius of 0.5 metres around the flue terminal of the **Prestige**.
- **The maximum flue resistance is 130 Pascal.** You can use the following table as the basis for calculating this value (*please also refer to the specimen calculation presented under the table*).

Table of flue resistance in Pascal

(1 Pascal = 0,01 mbar)

	Pipe concentric Ø 80/125 mm	Air inlet separate Ø 80 mm	Air extraction separate Ø 80 mm
1 m straight pipe	5.0	1.5	2.0
Pipe with a monitoring section	2.5	—	1.0
90° pipe bend	6.0	1.9	3.4
45° pipe bend	4.0	1.3	2.3
Vertical pipe	20.0	—	—
Horizontal pipe	15.0	—	—

This table is based on the equipment offered by ACV and cannot be applied generally.

Options for connection to the chimney

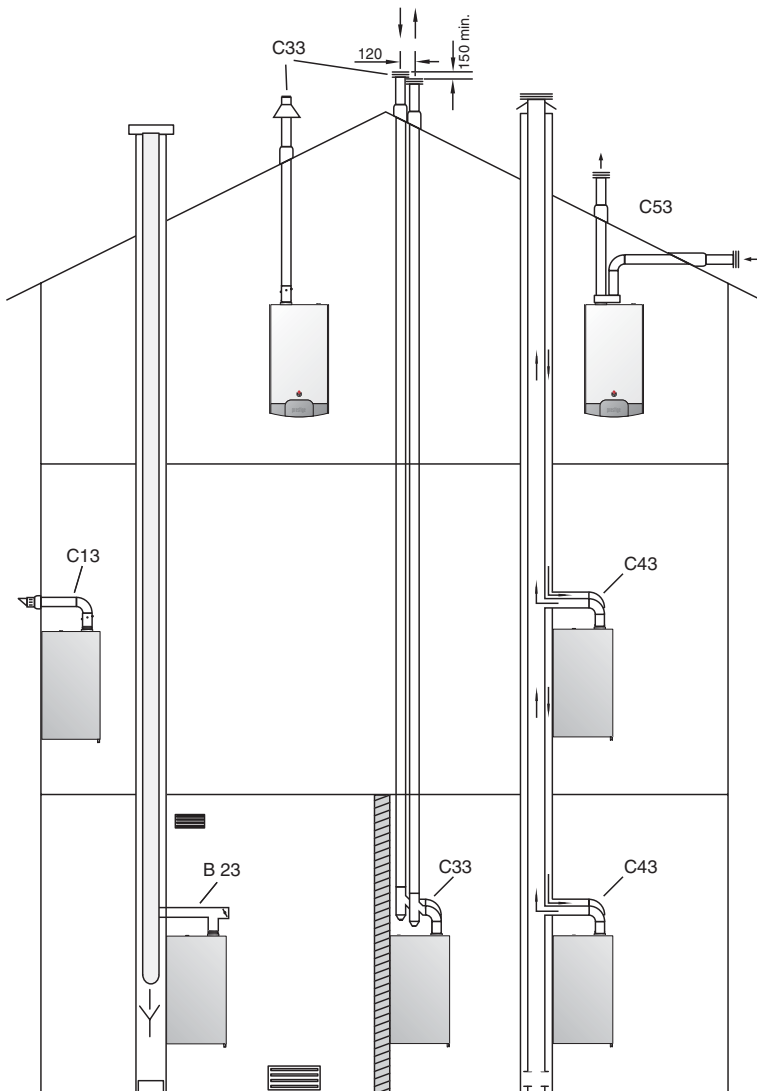

Sample calculation:

The diagram below consists of the following parts: pipe with monitoring section + 2 * 90° pipe bends + 2 metres of horizontal pipe + 2 * 45° pipe bends + (2 + 1 + 1) metres of vertical pipe and fall back + discharge.

Therefore, the resistance of this system is as follows:

$$2.5 + (2 \times 6.0) + (2 \times 5.0) + (2 \times 4.0) + (4 \times 5.0) + 20 = 72.5 \text{ Pa.}$$

This value is less than the maximum authorised resistance, therefore the installation is compliant.

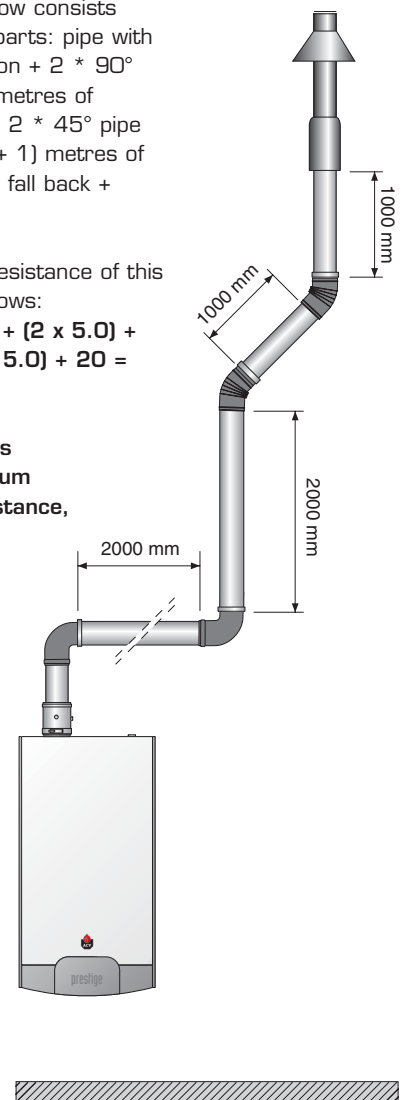

INSTALLATION

DOMESTIC HOT WATER CONNECTION PRESTIGE SOLO + SMART TANK

- Rinse the installation before connecting the domestic hot water circuit.
- Fill the tank before filling the heating circuit.

Optional accessories

Code Description

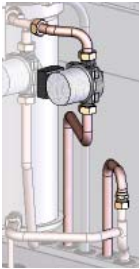

Domestic hot water hydraulic kit
Kit to connect a Prestige Solo boiler to an external water heater.

The kit includes :

- one circulator
- one NTC sensor 12kΩ (L = 3,2 m)
- one check valve
- three copper pipes + gaskets

10800079



NTC sensor 12kΩ:
Senses the temperature in the external hot water tank. (Delivered with the kit 10800079)

5476G003



Before any work on the boiler, it is important to disconnect the power supply.

It is important to carry out all the electrical connection before changing the MCBA parameters.

1. The 12kΩ NTC sensor must be inserted into the dywell and connected on terminals 3 and 4. (See the picture below).
2. Connect the DHW pump to the dedicated connector on the internal wiring (see the wiring diagram).

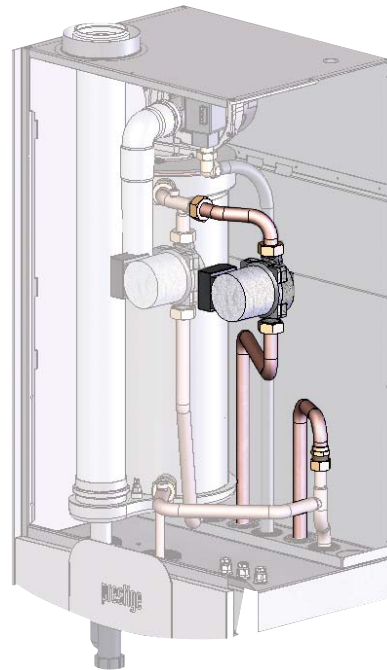
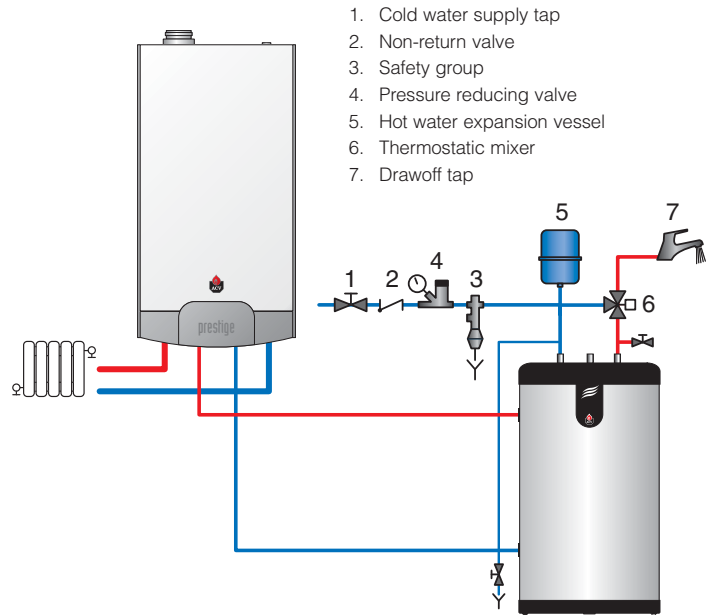
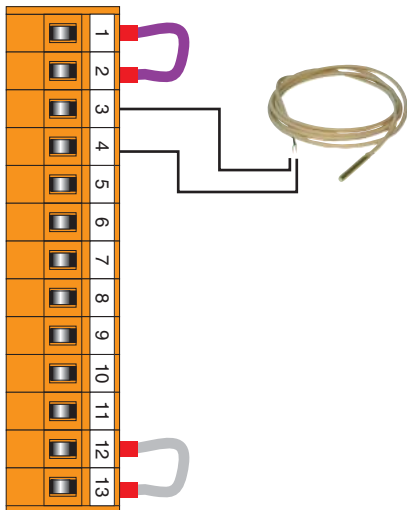

PARA factory setting	PARA typical setting	Description
1860	1867	Domestic hot water temperature setting (to be adjusted between 60 and 80°C).
2000	2001	00 : DHW Mode "OFF" 01 : DHW Mode "ON"
P035	P035	12 : Tank with NTC sensor 13 : Tank with control thermostat
0813	0812	

INSTALLATION

DOMESTIC HOT WATER CONNECTION PRESTIGE AQUASPEED / EXCELLENCE

The **Prestige AquaSpeed** and **Prestige Excellence** boilers can be connected directly on the domestic hot water circuit.

Flush out the system before connecting the domestic hot water part.

The installation must be fitted with an approved safety unit with a 6-bar safety valve, a non-return valve and a shut-off valve.

During the heating process, the domestic hot water dilates and the pressure increases. As soon as the pressure exceeds the safety valve setting, the valve opens and discharges a small quantity of water. Using a hot water expansion vessel (2 litres at least) will prevent this phenomenon and reduce water hammer effect.

Prestige AquaSpeed

If the flow demands become too high, the desired water temperature will not be reached. To avoid this phenomenon, we recommend that you place a flow limiter in the cold water pipe just before the appliance.

Prestige Excellence

Drain the tank by opening a hot water tap.

Caution: the presence of air in the circuit usually causes noisy air discharge effects.



The hot water output temperature may reach temperatures in excess of 60°C, which can cause burns. We therefore recommend that that you install a thermostatic mixer immediately after installing the appliance.



If stop valves are used in the domestic hot water system, they can cause pressure waves when closed. Use devices designed to reduce water hammer to avoid this phenomenon.

Prestige AquaSpeed

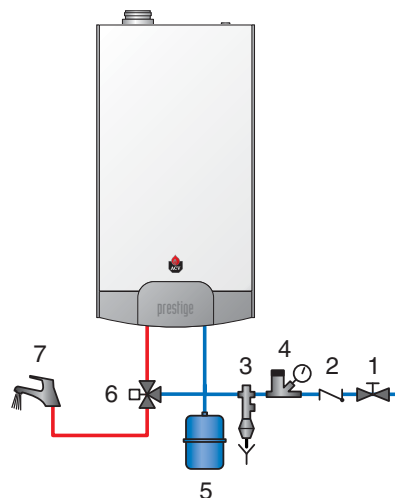

Prestige Excellence

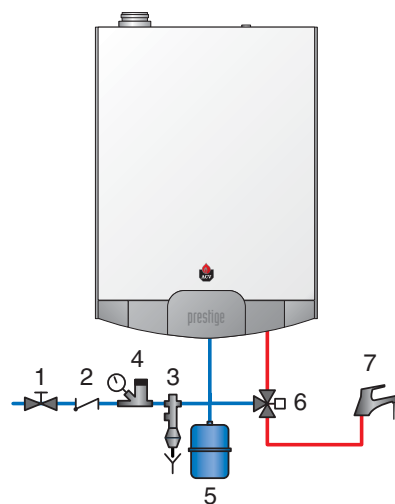

1. Cold water supply tap
2. Non-return valve
3. Safety group
4. Pressure reducing valve
5. Hot water expansion vessel
6. Thermostatic mixer
7. Drawoff tap

CONNECTION TO THE GAS

- The Prestige is fitted with a 3/4" male fitting connector, on which you can connect the gas tap.
- You must comply with the applicable regulations (e.g. NBN D51-003) for gas connections, and the other standards in force in the country of installation.
- Where there is a risk of dirt stemming from the network, place a gas filter upstream from the connection.

- Drain the gas pipe and check in minute detail that all the boiler pipes, both inside and outside, are sealed.
- Check the gas pressure in the system. Consult the technical characteristics.
- Check the gas pressure and consumption when commissioning the appliance.

HEATING CONNECTIONS

Recommendations

- The central heating system must be completely flushed out with tap water before connecting the boiler.
- Install the automatic air vent on the top of the appliance (Prestige AquaSpeed only). You will find this in the polystyrene packing.
- The device must be levelled, using the provided bracket, or the optional wall frame (*not available for the Prestige Excellence*).
- The operating noise can be increased if the appliance is fitted against a wall made of wood or other lightweight construction. Using rubber absorbers can reduce this effect.
- The connections to the central heating system and the domestic hot water system are provided with nuts. This simplifies the assembly with the optional wall frames. If you do not use the wall frames, then you must use flat connection type fittings with flat gaskets.
- The central heating safety valve is incorporated under the appliance and must be routed to the drain with an open connection (to allow inspection).
- The central heating pump is located inside the appliance. You can change its speed using the three position switch, depending on needs or if the pipes are noisy.
- The wall frames of the Prestige AquaSpeed and Solo are fitted with an integrated 12-litre expansion vessel.

Country dependant, the Prestige Excellence is equipped with a 12 litres expansion vessel.

This is sufficient for systems with a capacity of approximately 120 litres for the central heating. For larger-capacity systems, you can add a suitable expansion vessel to the AquaSpeed, the Prestige Solo and the Prestige Excellence for the central heating.

- Fill the system with fresh water. Contact your ACV representative about the use of inhibitors.
- **It is possible that the pumps are locked due to the presence of residual water from tests completed on the appliance. Therefore, we recommend that you unblock the pumps before filling the appliance.**
- You will find the connection for the filling valve and/or drainage valve on the bottom of the appliance. Fill the appliance to a minimum pressure of one bar. Drain the whole system and re-fill the appliance to a pressure of 1,5 bar.
- The system must be designed to ensure a continuous flow in the central heating circuit. If this flow is not guaranteed, for example if using thermostatic valves, you should install a pressure-dependent bypass in the system.
- Fit the siphon, fill it with tap water and connect the hose to the drain using a connection with an inspection section. Make sure you prevent the freezing of the condensates.

HEATING CONNECTIONS : GENERAL

1. By-pass with differential pressure valve
2. Isolating valve, heating system
3. Safety valve calibrated to 3 bar, with pressure gauge
4. System filling valve
5. Expansion vessel
6. Drain cock

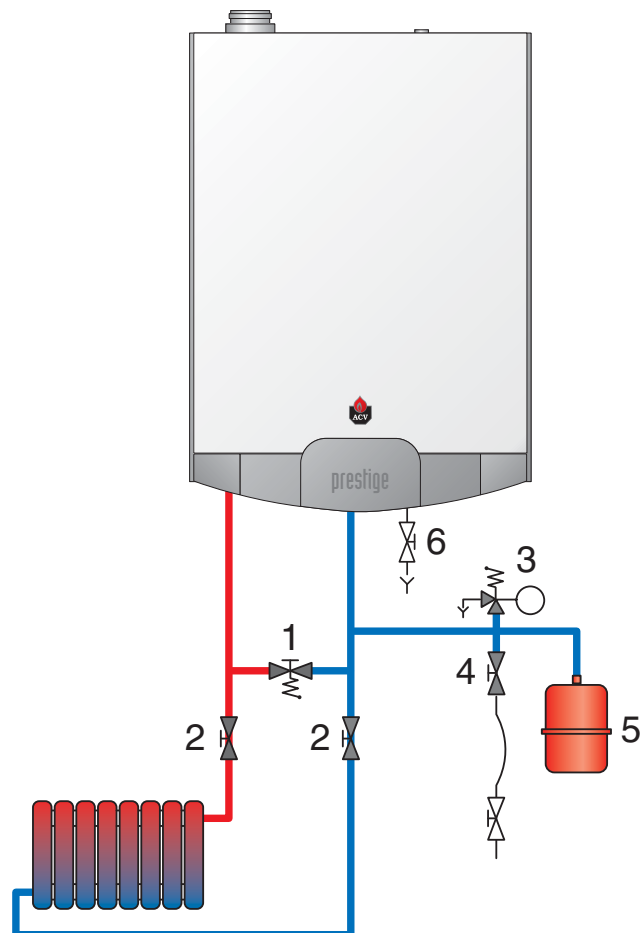

INSTALLATION

INSTALLATION OF A SIMPLE HEATING CIRCUIT CONTROLLED BY ROOM THERMOSTAT ACV 15

General diagram

The On/Off room thermostat controls the central heating system (radiators or convectors).

If an outside temperature sensor is connected, the boiler continuously adjusts its operating temperature depending on the outside temperature.

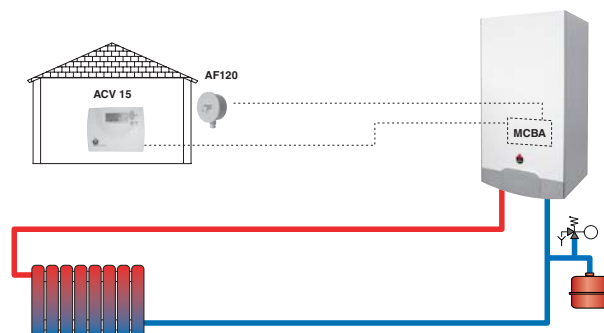

The pump is powered as soon as the room thermostat generates a heat demand.



Advantages for the user:

- Comfort
- Maximum Output
- Simplicity of the system

Optional accessories

	Code	Description
	10800018	Room thermostat ACV 15
	10510100	Outside temperature sensor 12kΩ — AF120

Remove this bridge

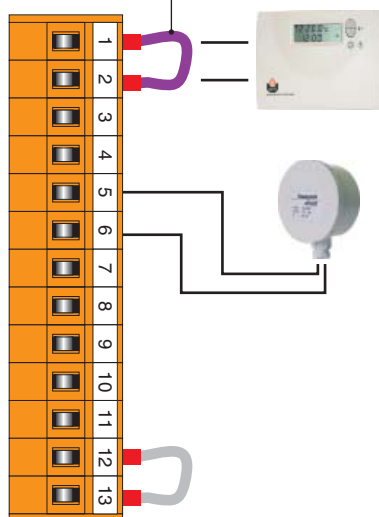

Factory setting	typical setting	Description
3.001	3.001	00 : Heating mode "OFF" 01 : Heating mode "ON"
4.85	4.85	Setting T° for the heating water (adjustable between 30 and 85°C).
P.05 1.30	P.05 1.30	T° min. for the heating water (adjustable between 15 and 60°C).
P.06 -10	P.06 -10	Minimum outside temperature (adjustable between -20 and 10°C).
P.07 18	P.07 18	Maximum outside temperature (adjustable between 15 and 25°C).
P.34 00	P.34 00	00 : Using a outside temperature sensor and a room thermostat

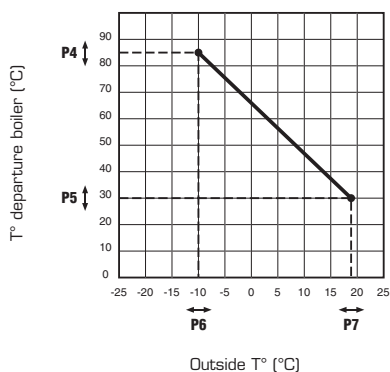

INSTALLATION

INSTALLATION OF A SIMPLE HEATING CIRCUIT CONTROLLED BY ROOM UNIT

General diagram

A Room Unit controls the heating system (radiators or convectors). The unit allows the selection various central heating functions and can be programmed for up to 3 schedules per week, both for heating and hot water production.

In this configuration, the boiler continuously adjusts its operating temperature in function of the outside temperature.

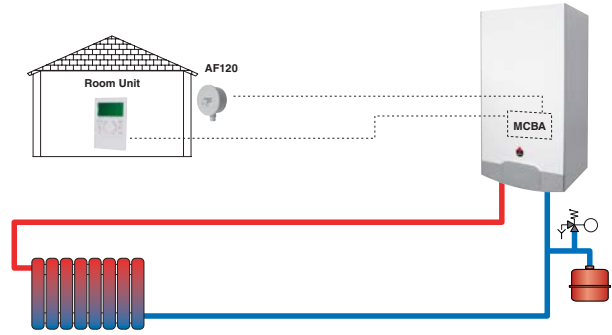

Optional accessories

Code Description



10800034 **Room Unit RSC**
Delivered with outside temperature sensor



10800036 **Clip-in interface RMCIEBV3**
Activates the communication between the MCBA and the Room Unit RSC.



10510100 **Outside temperature sensor 12kΩ — AF120**

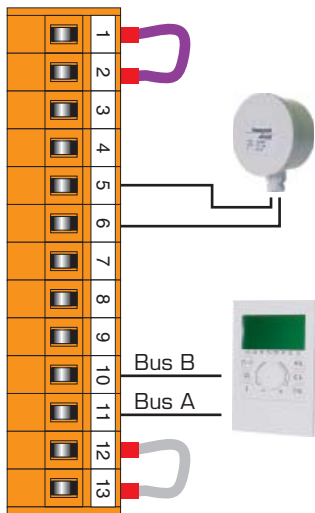

Factory setting	typical setting	Description
PARA	PARA	
3.001	3.001	00 : Heating mode "OFF" 01 : Heating mode "ON"
4.885	4.885	Setting T° for the heating water (adjustable between 30 and 85°C).
P.005	P.005	T° min. for the heating water (adjustable between 15 and 60°C).
0.030	0.030	

10800036: Interface address "0"

<input type="checkbox"/> <input type="checkbox"/> <input type="checkbox"/> = 0	<input type="checkbox"/> <input type="checkbox"/> <input type="checkbox"/> = 4
<input type="checkbox"/> <input type="checkbox"/> <input type="checkbox"/> = 1	<input type="checkbox"/> <input type="checkbox"/> <input type="checkbox"/> = 5
<input type="checkbox"/> <input type="checkbox"/> <input type="checkbox"/> = 2	<input type="checkbox"/> <input type="checkbox"/> <input type="checkbox"/> = 6
<input type="checkbox"/> <input type="checkbox"/> <input type="checkbox"/> = 3	<input type="checkbox"/> <input type="checkbox"/> <input type="checkbox"/> = 7

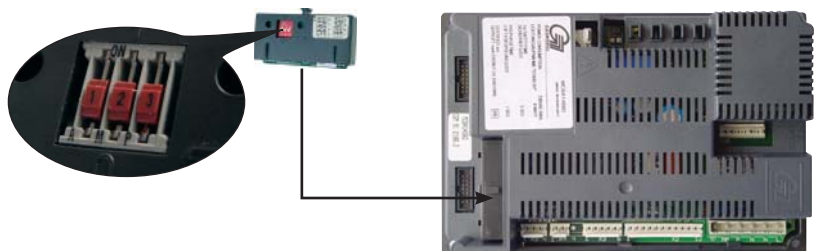

INSTALLATION

INSTALLATION OF TWO HEATING CIRCUIT CONTROLLED BY ROOM THERMOSTAT ACV 15 AND AM3-11 MODULE

General diagram

This is a simple way to control two heating circuits (radiators or floor heating).







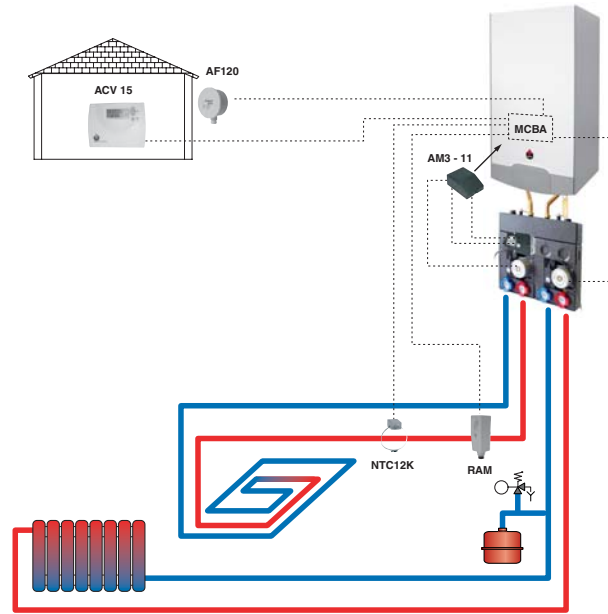

You can adjust those two circuits depending on the outside temperature.

This is the ideal configuration for floor heating with additional heating provided by radiators.

The floor heating temperature is adjusted on a first temperature diagram, while the radiator loop follows a second temperature diagram, if needed with a booster function.



Optional accessories

	Code	Description
	10800018	Room thermostat ACV 15
	10800095	AM3-11 module : Controls the second heating circuit - communicates directly with the MCBA
	537D3040	Contact sensor 12kΩ To be mounted on the outlet of controlled circuit
	10510900	Contact thermostat RAM 5109 : Required to protect all floor heating circuits
	10510100	Outside temperature sensor 12kΩ — AF120
	10800077	Collector 2 circuits DN20 : With bypass, connecting tubes and integrated wall brackets
	10800097	High temperature kit DN20 Including: one circulation pump, two isolating valves, check valve, two thermometers
	10800096	Low temperature kit DN20 Including: one circulation pump, two isolating valves, check valve, two thermometers, the 4-way valve with integrated bypass.
	10800019	Servomotor SQK 349 : Electromechanical servomotor SQK 349 for the three-way valve included in low temperature kit (opening times : 150 seconds)

INSTALLATION

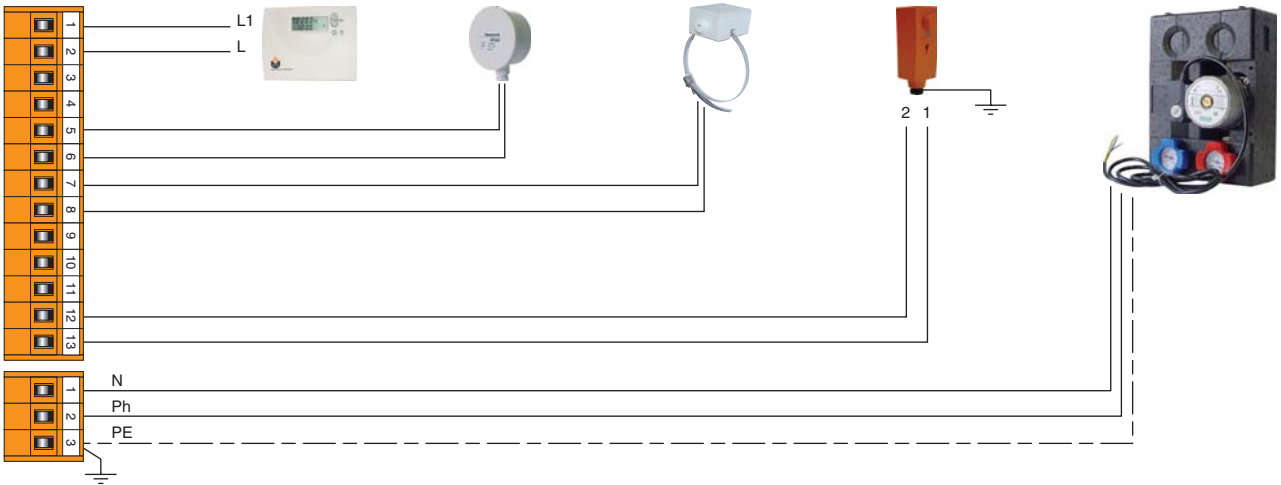

To be wired in accordance with the applicable regulations.

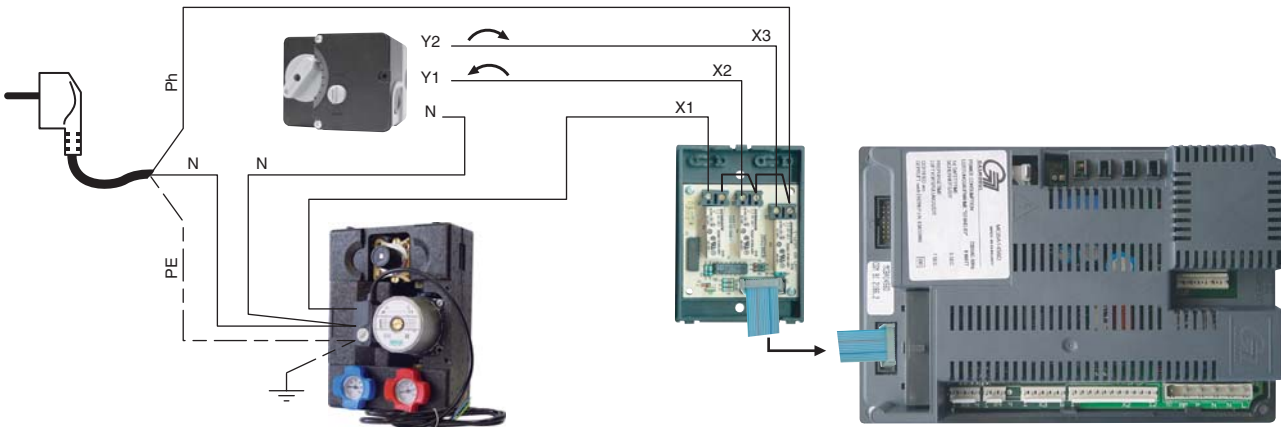

PARA Factory setting	PARA typical setting	Description
3.01	3.01	00 : Heating mode "OFF" 01 : Heating mode "ON"
4.85	4.85	Setting T° for the heating water (adjustable between 30 and 85°C).
P.05 1.30	P.05 1.30	T° min. for the heating water (adjustable between 15 and 60°C).
P.06 -10	P.06 -10	Minimum outside temperature [T4] (adjustable between -20 and 10°C).
P.07 18	P.07 18	Maximum outside temperature [T4] (adjustable between 15 and 25°C).
P.11 10	P.11 00	Booster
P.34 00	P.34 20	- The high T° circuit is controlled depending on the outside T° and the room thermostat. - The low T° circuit is controlled depending the outside T° only.

PARA Factory setting	PARA typical setting	Description
P.39 50	P.39 50	Maximum temperature of the second heating circuit
P.40 20	P.40 20	Minimum temperature of the second heating circuit

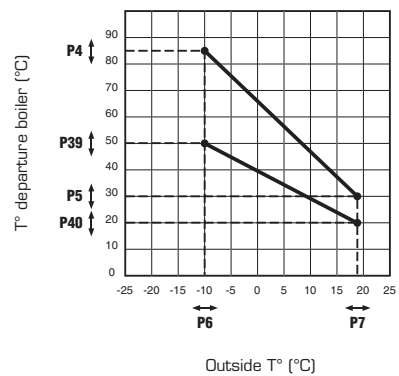

INSTALLATION

INSTALLATION OF TWO HEATING CIRCUIT CONTROLLED BY CONTROL UNIT AND ZMC-1 MODULE

General diagram

This configuration controls two heating circuits (radiators or floor heating). In addition, the Room unit features a remote monitoring of the two circuits

You can adjust those two circuits depending on the outside temperature.





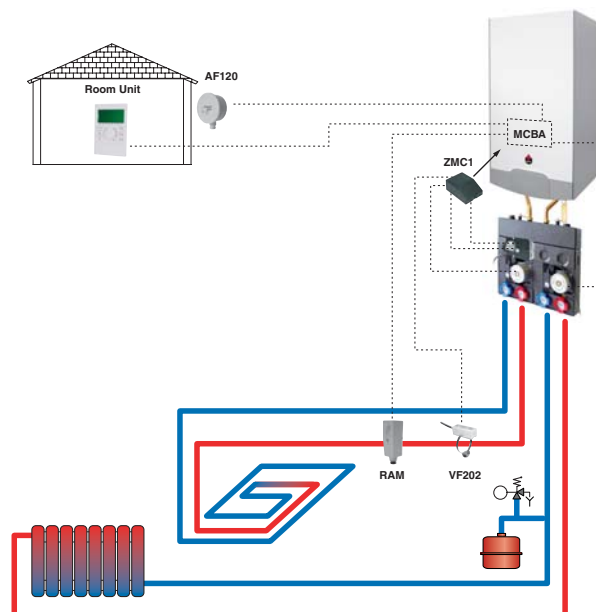





This is the ideal configuration for floor heating with additional heating provided by radiators.

You can select various heating functions, and program up to three weekly schedules, as well for the central heating as for the hot water production.



Optional accessories

Code Description

	10800034	Room Unit RSC Supplied with outside temperature sensor
	10800119	ZMC-1 module (kit) : Controls the second heating circuit - alarm contact - operates only in conjunction with the Room Unit RSC.
	10800036	Clip-in interface RMCIEBV3 Enables communications between the MCBA and the Room Unit RSC.
	10800045	Contact sensor 2kΩ — VF202 : To be mounted on the outlet of controlled circuit
	10510900	Contact thermostat RAM 5109 : Required to protect all floor heating circuits
	10510100	Outside temperature sensor 12kΩ — AF120
	10800077	Collector 2 circuits DN20 : With bypass, connecting tubes and integrated wall brackets
	10800097	High temperature kit DN20 Including: one circulation pump, two isolating valves, check valve, two thermometers
	10800096	Low temperature kit DN20 Including: one circulation pump, two isolating valves, check valve, two thermometers, the 4-way valve with integrated bypass.
	10800019	Servomotor SQK 349 : Electromechanical servomotor SQK 349 for the three-way valve included in low temperature kit (opening times : 150 seconds)

INSTALLATION

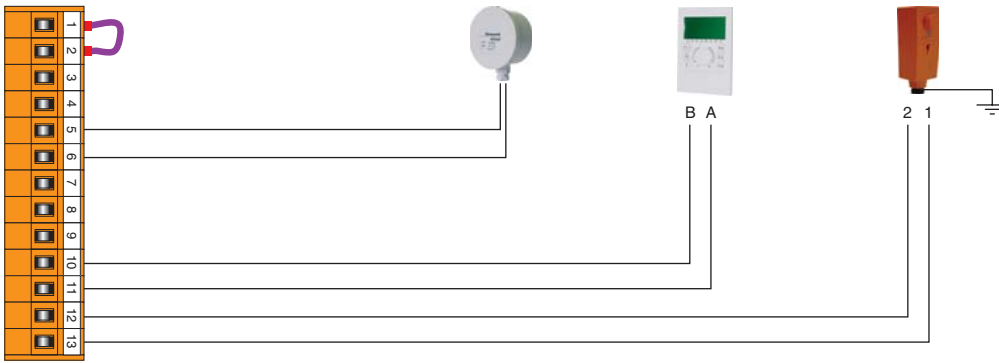

To be wired in accordance with the applicable regulations.

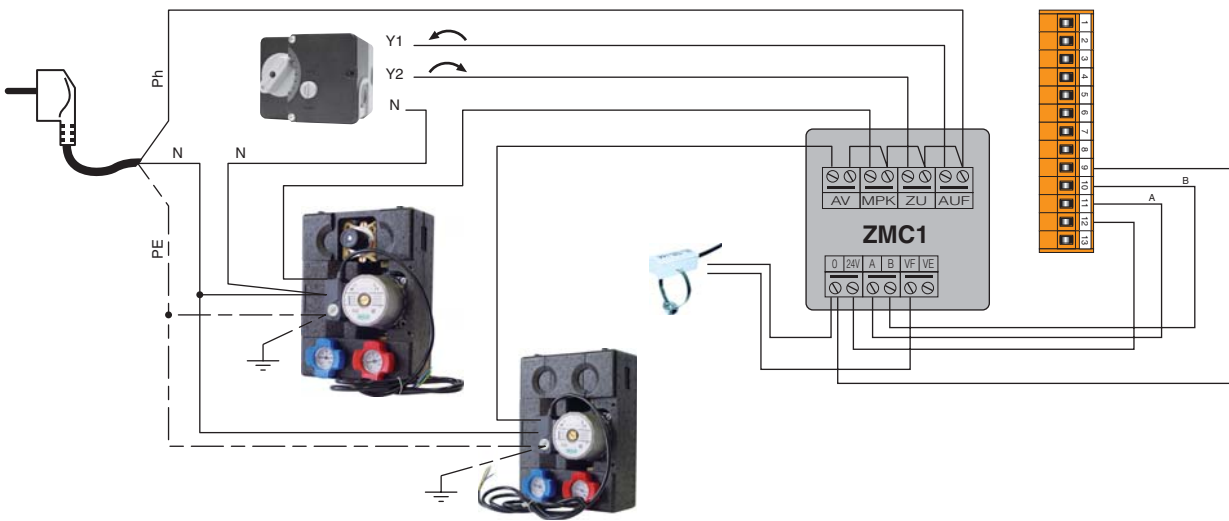

10800036: Interface address "0"

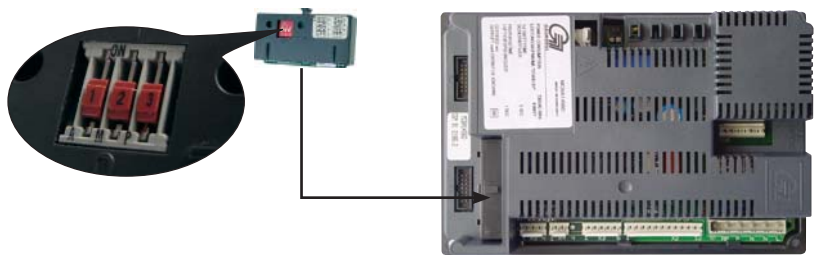
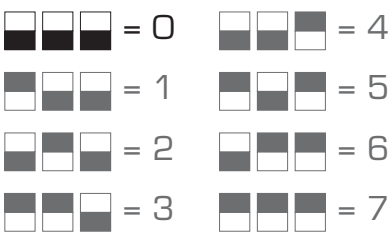

Hydraulic parameter 6 = 23

PARA Factory setting	PARA typical setting	Description
3.01	3.01	00 : Heating mode "OFF" 01 : Heating mode "ON"
4.85	4.85	Setting T° for the heating water (adjustable between 30 and 85°C).
P.05 1.30	P.05 1.30	T° min. for the heating water (adjustable between 15 and 60°C).

ELECTRICAL CONNECTION

WIRING DIAGRAM : PRESTIGE 24-32 / Solo – AquaSpeed – Excellence

- 1. 230V connection cord
- 2. Start/Stop switch
- 3. Water tank charging pump socket
- 4. Heating pump
- 5. Burner
- 6. Gas valve
- 7. 230Volt - 24Volt transformer
- 8. MICBA
- 9. Screen
- 10. Water pressure switch
- 11. NTC1 flow sensor

- 12. NTC2 return sensor
- 13. NTC3 domestic hot
- 14. NTC5 flue gas temperature
- 15. Room thermostat (optional)
- 16. NTC4 outdoor temperature
- 17. NTC6 sensor for the circuit (optional)
- 18. Shell B (optional)
- 19. Shell A (optional)
- 20. Zero volt of 24V circuit.
- 21. Connection pumps (if two circuit)

- B. Blue
- Bk. Black
- Br. Brown
- G. Grey
- Or. Orange
- R. Red
- V. Violet
- W. White
- Y/Gr. Yellow/Green

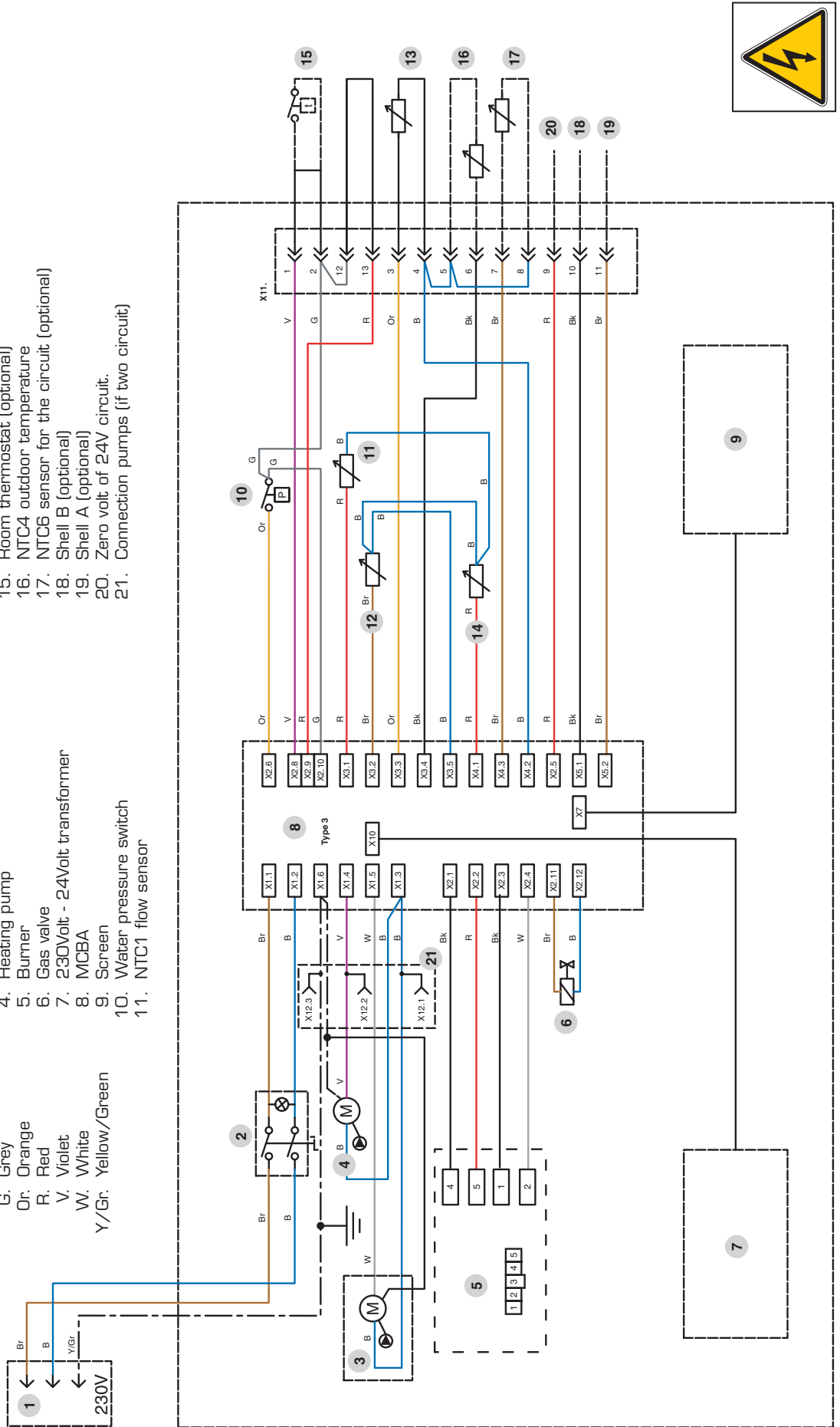

COMMISSIONING THE SYSTEM



- Slowly fill the tank and drain it by opening a hot water tap. Drain all the taps and check that there are no leaks in the domestic hot water system.
- Fill the whole system up to a minimum pressure of 1 bar (preferably 1.5 bar), using the boiler's fill valve. Fill the system slowly and drain it using the central heating flow pipe manual air vent. Also check that the automatic air vent (**AquaSpeed**) on the tank is working. Check that there are no leaks in the central heating system.
Prestige excellence: purge the primary circuit of the tank by means of the manual air vent on the top of the tank.
- Purge the circulator(s)
- Open the gas valve, drain the pipe and check that there are no leaks in the system.
- Check that the siphon is filled.
- Connect the plug to the wall socket and power on the appliance. If needed, place the room thermostat to its highest position. The boiler should start. Check the gas pressure and allow the boiler to heat up for a few minutes. Set the boiler to High Power mode and check the CO₂ level (see the table of Technical Characteristics). Then, set the boiler to Low Power mode and check the CO₂ level again (see the table of Technical Characteristics).
- Set the central heating and hot water temperatures following the values given in the Directions for Use.
- Drain the central heating system again and, if necessary, re-fill it.
- Make sure the central heating system is correctly balanced and, if necessary, adjust the valves to prevent a greater or lesser flow than planned to some circuits or radiators.

CHECKING THE SETTINGS

- Check that the parameters are set in accordance with the user's needs: see page 3, Directions for Use.
- Check the boiler settings: this task can only be carried out by an ACV-trained installer or by the ACV maintenance department.
- Set the appliance to High Power mode by simultaneously pressing the mode and Plus keys.
- Check the dynamic gas pressure at the gas valve (see diagram below, ref. 1). This must be at least 18 mbars.
Wait a few minutes for the appliance to heat up to a minimum temperature of 60°C. Check the CO₂ setting using a measurement instrument. Please see in the Technical Characteristics for optimum value. To increase the CO₂ value, turn the venturi screw counterclockwise; turn it clockwise to reduce the value (see diagram below ref. 2).
Then put the appliance to High Power mode by simultaneously pressing the mode and Plus keys. Wait a few minutes to stabilise. Check the CO₂ value. It should be either equal to the full power value or a maximum of 0.5% less than this value. If you record

a significant deviation, please contact the ACV maintenance department.

INSPECTION AND MAINTENANCE



ACV recommends that you have your boilers inspected and cleaned if need be at least once a year.

Plug out the appliance before undertaking any work, even if only recording measurements and adjusting the settings.

- Check that the siphon is not fouled, fill it, if need be, and check that there are no leaks.
- Check that the safety valves are operating correctly.
- Drain the whole system and if necessary re-fill the appliance to pressure of 1.5 bar.



If you have to refill your circuit more than twice a year, please contact your installer.

- Check the boiler charge in High Power mode. If there is a big difference between this value and the original setting, the deviation could mean a blockage in the air intake pipes or flue gas extraction pipes, or that the exchanger has become fouled with an accumulation of dirt.
- **AquaSpeed**: Check the domestic hot water flow and the temperature. These values could indicate a poorly regulated flow limiter (new setting) or, in areas where the water is very hard, gradual scale formation in the exchanger. To clean the **AquaSpeed** minitank with chemicals, you can connect the descaling pump directly to the hot and cold water connection. Follow the manufacturer's instructions for using the descaler and the descaling product or contact your ACV distributor for more information.

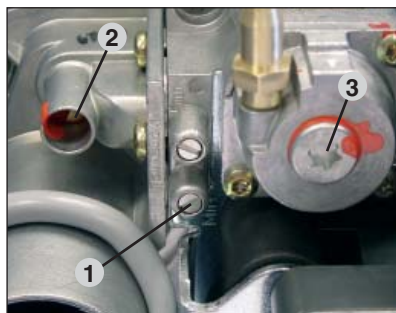

Ref.3
The gas valve offset setting is a sealed factory setting. In principle, it may not be modified.



DISASSEMBLING THE BURNER

- Close the inlet gas valve.
- Remove the front panel of the boiler.
- Unplug the fan plugs (24 Volt), the ignition cable, the gas valve control and the ignition electrode earth.
- The upper jacket panel is removable for an easier access.
- Loosen the 4 burner nuts using a ratchet wrench.
- Unscrew the three-way coupling on the gas pipe.
- In one unit, lift up the burner with the fan and the gas valve to remove them from the exchanger. Be careful not to damage the burner insulation in the exchanger.
- Check the condition of the insulation and the seals and replace them if necessary before re-assembling the burner following the same procedure but in the reverse order.

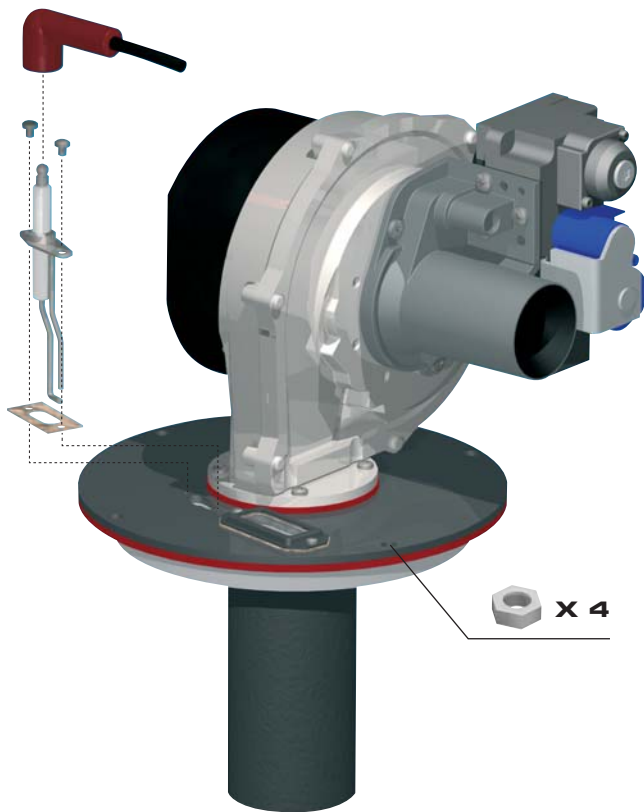

DISASSEMBLING AND CHECKING THE ELECTRODE

- Remove the ignition cable.
- Remove the two fixing screws.
- Remove the electrode earth but make sure the serrated washer is fixed between the earth cable and the electrode when re-assembling.
- Check the condition of the seals and replace them if necessary before re-assembling the electrode following the same procedure but in the reverse order.

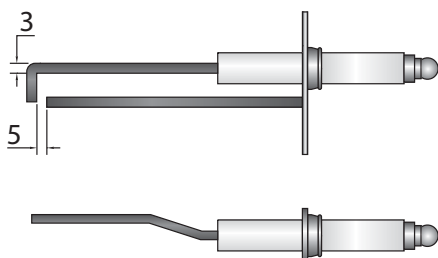

DISASSEMBLING THE EXCHANGER

- Drain the water from the central heating system using the connection under the appliance.
- Allow the appliance to drain completely.
- Dismantle the electrical connections downstream from the burner, as well as the NTCs.
- Dismantle the exchanger central heating flow pipes and return pipes. Exercise caution when dismantling the parts as residual water may escape from the exchanger.
- Dismantle the connection at the siphon and remove the nut between the siphon and the exchanger.
- Lift up the exchanger in one piece standing upright. The exchanger detaches from its hook and is fully released.
- Check the condition of the seals and replace them if necessary before re-assembling the

AQUASPEED: DISASSEMBLING THE INVERTED TANK

- Disconnect all the central heating connections as well as all the hot and cold water pipes connected to the boiler.
- Empty the central heating system using the fill/drain valve located under the appliance.
- Disconnect the electrical connection for the charging pump by pulling out the plug.
- Remove the MCBA assembly plate.
- Unscrew the central heating flow pipe using the three-way coupling located on top of the charging pump.
- Unscrew the mini-tank return pipe.
- Disconnect the hot and cold water pipes from the mini-tank.
- Remove the air vent located above the mini-tank, as well as the nut located below.
- Remove the mini-tank from the lining and tilt it forwards to remove it completely.
- Check the condition of the seals and replace them if need be before re-assembling the mini-tank.

CLEANING THE HEAT EXCHANGER

- Remove the burner assembly as described above.
- Remove the burner gasket.
- Clean the combustion chamber using a vacuum cleaner.
- Disconnect the flue pipe from the exchanger.
- Check if the condensates collector is clean, if necessary, clean it.
- Check the burner insulation and the burner gasket; replace the parts if necessary.
- Check the igniter, replace if necessary
- Reassemble the burner and check for leakages.
- Power up the appliance, set the boiler in full power mode and recheck for leaks.
- Check the gas pressure and the CO₂ level as explained in previous paragraph.

TEMPERATURE SENSOR RESISTANCE TABLES

T° [°C]	R Ω	T° [°C]	R Ω	T° [°C]	R Ω
- 20	98200	25	12000	70	2340
- 15	75900	30	9800	75	1940
- 10	58800	35	8050	80	1710
- 5	45900	40	6650	85	1470
0	36100	45	5520	90	1260
5	28600	50	4610	95	1100
10	22800	55	3860	100	950
15	18300	60	3250		
20	14700	65	2750		

MCBA PARAMETERS FOR THE SPECIALIST

STANDBY MODE

Standby Mode

5t64

After you power down the appliance the screen displays Pilot mode, as shown in the figure above.

This is the standard MCBA mode. The MCBA automatically returns to this mode after 20 minutes if no keys have been pressed on the screen. Any parameters that were modified are then enabled.

The first character shows the current status of the boiler depending on the condition of both the boiler and the burner. The last 2 characters indicate the start temperature.

Once the cause of the blockage has been resolved, the burner starts automatically within 150 seconds at most.

Status	Boiler function
0 388	Standby, no demand for heat
1 388	Fan first, fan after
2 388	Ignition
3 388	Operation of the boiler burner for the heating
4 388	Operation of the boiler burner for the domestic hot water
5 388	Air pressure limit or obtaining the number of start revolutions
6 388	The burner goes out when the specified value is reached. A demand for heat is present nonetheless.
7 388	Pump over-run time after the demand for central heating
8 388	Pump over-run time after the demand for domestic hot water
9 388	Burner blocked: <ul style="list-style-type: none"> • 6 18 : T1 > 95°C • 6 19 : T2 > 95°C • 6 24 : T2 - T1 > 10°C after 90 seconds • 6 25 : dT1/dt > maximum gradient T1 • 6 26 : water pressure switch not off • 6 28 : no fan signal • 6 29 : erroneous fan signal • 6 30 : T1 - T2 > max. Δ • 6 33 : NTC3 short-circuit • 6 35 : NTC5 short-circuit • 6 38 : NTC3 interrupt • 6 40 : NTC5 interrupt • 6 52 : T5 > T5 max • 6 65 : wait for the fan to start

Status	Boiler function
A 388	Internal check — three-way valve
C 388	Boiler burner in hot water ready function
H 388	Test function: Central heating high power
L 388	Test function: Central heating low power
E 388	Test function: Boiler with fixed number of revolutions

If the burner is blocked for one of the reasons mentioned above, the screen display alternates between a 9 followed by the temperature (two last digits) and b with the error code.

MCBA PARAMETERS FOR THE SPECIALIST



SETTING THE MCBA PARAMETERS



















Parameter Mode 

To access Parameter mode when the system is in Pilot mode, press **MODE** once.

To scroll through the list of parameters, simply press “**step**”. To modify a parameter value, use the + or - keys. Then press “**Store**” to save the value you just changed. The screen flashes once to confirm the data has been saved.

To activate the parameters you changed, press **MODE** once more (which brings you into Info mode). However, if you do not press a key, the system returns to Pilot mode after 20 minutes and automatically enables the changes.

Key	Screen
 MODE	

Key	Screen	Description of parameters	Factory setting		
			Solo	AquaSpeed	Excellence
 STEP		Adjusting the hot water temperature			
 STEP		Production of hot water 00 = Stop 01 = Start 02 = Stop + pump continuously on 03 = Start + pump continuously on			
 STEP		Turn On/ Turn Off the heating 00 = Stop 01 = Start 02 = Stop + pump continuously on 03 = Start + pump continuously on			
 STEP		Maximum temperature in Central Heating mode			



MCBA PARAMETERS FOR THE SPECIALIST

REQUEST FOR INFORMATION ON THE INSTALLATION











Info Mode

INFO

To switch from **Standby** to **Info** mode, press **Mode** twice.

Key	Screen
	PARA
MODE	
	INFO
MODE	

Press **STEP** until the system displays the information you need. The point located behind the first position flashes to indicate that the boiler is in **INFO** mode.

Key	Screen	Description of parameters
	1.60	Start temperature T1 in °C
STEP		
	2.50	Return temperature T2 in °C
STEP		
	3.65	Hot water temperature T3 in °C
STEP		
	4.03	Outdoor temperature T4 in °C
STEP		
	5.55	Flue gas temperature
STEP		
	6.45	Start temperature calculated in °C
STEP		
	7.00	Rate of increase in the start temperature in °C/s
STEP		
	8.00	Rate of increase in the return temperature in °C/s
STEP		
	9.00	Rate of increase in the hot water temperature in °C/s
STEP		
	A.34	Start temperature of the 2nd central heating circuit
STEP		

ENTERING THE CODE

Code Mode



CODE

You can access the following parameters by entering the service code:

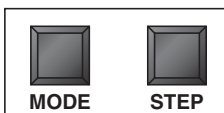

- Parameters 5 - 42
- Communication mode
- Fan Speed mode
- ERROR mode

Stby



To access Code mode, press **MODE** and **STEP** simultaneously (only from Standby mode!).

→

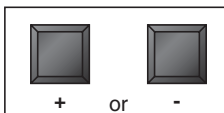

Press **STEP** once and the system displays **C** in position 1, followed by arbitrary characters in positions 3 and 4.

→

Press + or - to change the code..

→

Press **STORE**, the screen flashes briefly to indicate that the code has been accepted.

→

Press **MODE** until the system displays the correct mode.

 Only ACV authorised installers know the access code.

For further information, please contact our after-sales department.

MCBA PARAMETERS FOR THE SPECIALIST

MCBA PARAMETERS WITH CODE RESTRICTED ACCESS

Factory setting

Key	Screen	Description of parameters	Solo	AquaSpeed	Excellence
STEP	P.05	Minimum central heating temperature when using an outdoor sensor	23.30	23.30	23.30
STEP	P.06	Minimum outdoor temperature [adjust the heating curve]	2.-10	2.-10	2.-10
STEP	P.07	Maximum outdoor temperature [adjust the heating curve]	23.18	23.18	23.18
STEP	P.08	Frost protection temperature	23.01	23.01	23.01
STEP	P.09	Correction based on the outdoor temperature	23.00	23.00	23.00
STEP	P.10	Blockage T 0 = Disabled	23.00	23.00	23.00
STEP	P.11	Acceleration time lag 00 = Stop [minute]	23.10	23.10	23.10
STEP	P.12	Night set back heating (°C)	23.10	23.10	23.10
STEP	P.13	Prestige 32 natural gas	23.55	23.55	23.55
		Prestige 24 natural gas	23.43	23.43	23.43
		Prestige 32 propane	23.59	23.59	23.59
		Prestige 24 propane	23.47	23.47	23.47
STEP	P.14	Prestige 32 natural gas	23.50	23.50	23.50
		Prestige 24 natural gas	23.00	23.00	23.00
		Prestige 32 propane	23.00	23.00	23.00
		Prestige 24 propane	23.00	23.00	23.00

MCBA PARAMETERS FOR THE SPECIALIST

Factory setting

Key	Screen	Description of parameters	Factory setting			
			Solo	AquaSpeed	Excellence	
STEP	P. 15	Max. number of revs in domestic hot water mode [rpm x 100]	Prestige 32 natural gas	55	55	55
			Prestige 24 natural gas	43	43	43
			Prestige 32 propane	59	59	59
			Prestige 24 propane	47	47	47
STEP	P. 16	Maximum number of fan revolutions in domestic hot water mode [rpm]	Prestige 32 natural gas	50	50	50
			Prestige 24 natural gas	00	00	00
			Prestige 32 propane	00	00	00
			Prestige 24 propane	00	00	00
STEP	P. 17	Minimum number of fan revolutions [rpm x 100]	Prestige 32 natural gas	15	15	15
			Prestige 24 natural gas	15	15	15
			Prestige 32 propane	15	15	15
			Prestige 24 propane	15	15	15
STEP	P. 18	Minimum number of fan revolutions [rpm]	Prestige 32 natural gas	00	00	00
			Prestige 24 natural gas	00	00	00
			Prestige 32 propane	00	00	00
			Prestige 24 propane	00	00	00
STEP	P. 19	Number of fan revolutions at ignition [rpm x 100]	Prestige 32 natural gas	36	36	36
			Prestige 24 natural gas	36	36	36
			Prestige 32 propane	36	36	36
			Prestige 24 propane	36	36	36
STEP	P. 20	CH pump over-run 0 = 10 sec. [step = 1 minute]	05	05	05	
STEP	P. 21	Domestic hot water pump over-run time [step = 10.2 sec]	16	07	16	









































MCBA PARAMETERS FOR THE SPECIALIST

Factory setting

Key	Screen	Description of parameters	Solo	AquaSpeed	Excellence
STEP	P. 22	Central Heating modulation hysteresis enabled	0.03	0.03	0.03
STEP	P. 23	Central Heating modulation hysteresis disabled	0.03	0.03	0.03
STEP	P. 24	Domestic hot water modulation hysteresis enabled	0.00	-0.02	0.00
STEP	P. 25	Domestic hot water modulation hysteresis disabled	0.06	0.08	0.06
STEP	P. 26	Detection of domestic hot water hysteresis enabled	0.10	0.10	0.10
STEP	P. 27	Detection of domestic hot water hysteresis disabled	0.00	0.00	0.00
STEP	P. 28	Central Heating blockage time [sec. x 10,2]	0.05	0.05	0.05
STEP	P. 29	Domestic hot water blockage time [sec. x 10,2]	0.00	0.00	0.00
STEP	P. 30	Domestic hot water □ Central Heating blockage time [sec. x 10,2]	0.20	0.06	0.20
STEP	P. 31	Re-modulate the difference T1 - T2	0.30	0.30	0.30
STEP	P. 32	Shell address [-1 = disabled]	-0.1	-0.1	-0.1
STEP	P. 33	Temperature increase set point for the production of hot water	0.20	0.10	0.20
STEP	P. 34	<p>first position: 2nd heating circuit: 0 = disabled 1 = enabled [slave] 2 = enabled [master]</p> <p>Second position: the demand for heat comes from: 0 = the room thermostat 1 = the outdoor sensor</p>	0.00	0.00	0.00

MCBA PARAMETERS FOR THE SPECIALIST



Factory setting





Key	Screen	Description of parameters	Factory setting		
			Solo	AquaSpeed	Excellence
 STEP		First position: Domestic hot water pump [1] or three-way mixer tap [2] Second position: tank with NTC3 probe [2] or tank with thermostat (3)			
 STEP		Manual fan number of revolutions			
 STEP		First position: Fan control pump level during burning in Second position: Fan control pump level during over-run time			
 STEP		Hold temperature			
 STEP		Maximum temperature for the start heating curve for the 2nd circuit			
 STEP		Minimum temperature for the start heating curve for the 2nd circuit			
 STEP		2nd circuit temperature hysteresis			
 STEP		First position: Special pump [0 = disabled] Second position: Minimum disable cycle [0 = disabled]			

MCBA PARAMETERS FOR THE SPECIALIST





COMMUNICATION MODE [with code]

When in this mode, the system displays the communication between the boiler and the control module, the optional interface kit or the optional programmable room thermostat.

Key	Screen
	
MODE	



Key	Screen	Description of parameters
		No communication
		Communication between the boiler module and the optional control modules only
		Communication between all the devices connected













FAN MODE [with code]

Key	Screen	Description of parameters
		Fan speed
		The current fan speed is 5,500 rpm.

ERROR MODE [with code]

ERROR mode indicates the most recent error, as well as the status of the boiler and its readings at the time this error occurred.

Key	Screen
	
MODE	

Key	Screen	Description of parameters
		Code mode
		Status of the boiler at the time of the error
		Start temperature T1 at the time of the error
		Return temperature T2 at the time of the error
		Hot water temperature T3 at the time of the error
		Outdoor temperature T4 at the time of the error

MCBA PARAMETERS FOR THE SPECIALIST

SAFETY STOP [ERROR mode]

If a fault occurs while the appliance is running, the system locks and the screen starts to flash. The first character is an E and the next two characters give the code for this fault, as illustrated in the table below.



To unlock the system:

- Press **RESET** on the screen.
- Contact your installer if the fault happens again.

Codes	Description of the fault	Resolution of the fault
	Abnormal flame signal	<ul style="list-style-type: none"> - Check the wiring (short-circuit in the 24V wiring) - Check the electrode - Replace the MCBA (water damage)
	No flame signal after five attempts at firing the boiler	<ul style="list-style-type: none"> - Check the ignition cable - Check the electrode and the position of the electrode - Check that there is gas at the burner.
	Internal error	If the problem persists after two RESET attempts, replace the MCBA.
	Persistent lock	Press "RESET"
 	Internal error	If the problem persists after two RESET attempts, replace the MCBA.
	EPROM error	If the problem persists after two RESET attempts, replace the MCBA.
	Max input, thermostat open or 24V fuse gone.	<ul style="list-style-type: none"> - Check the wiring - Check the 24V fuse on the MCBA.
 	Internal error	If the problem persists after two RESET attempts, replace the MCBA.
	T1 > 110°C	<ul style="list-style-type: none"> - Check the NTC wiring and replace if necessary. <p>If NTC1 is OK, please verify that the water flows through the boiler.</p>
	T2 > 110°C	<ul style="list-style-type: none"> - Check the NTC wiring and replace if necessary.
	T1 gradient too high	<ul style="list-style-type: none"> - Check that the pump is turning. - If there is no problem with the pump, drain the system.
	No fan signal present	<ul style="list-style-type: none"> - Check the fan control connection - Check the fan wiring <p>If the problem persists after two RESET attempts, replace the MCBA.</p>
	The tachometer signal of the blower does not go to zero.	<ul style="list-style-type: none"> - Check that the convection flow through the chimney is not high enough to rotate the blower. <p>If not, exchange the blower.</p>
	NTC1 short-circuit	<ul style="list-style-type: none"> - Check the connection of the NTC1 sensor - Check the wiring of the NTC1 sensor <p>If the problem persists, replace the NTC1 sensor</p>
	NTC2 short-circuit	<ul style="list-style-type: none"> - Check the connection of the NTC2 sensor - Check the wiring of the NTC2 sensor <p>If the problem persists, replace the NTC2 sensor</p>

MCBA PARAMETERS FOR THE SPECIALIST

Codes	Description of the fault	Resolution of the fault
E833	NTC3 short-circuit	<ul style="list-style-type: none"> - Check the connection of the NTC3 sensor - Check the wiring of the NTC3 sensor <p>If the problem persists, replace the NTC3 sensor</p>
E836	NTC1 connection open	<ul style="list-style-type: none"> - Check the connection of the NTC1 sensor - Check the wiring of the NTC1 sensor <p>If the problem persists, replace the NTC1 sensor</p>
E837	NTC2 connection open	<ul style="list-style-type: none"> - Check the connection of the NTC2 sensor - Check the wiring of the NTC2 sensor <p>If the problem persists, replace the NTC2 sensor</p>
E838	NTC3 connection open	<ul style="list-style-type: none"> - Check the connection of the NTC3 sensor - Check the wiring of the NTC3 sensor <p>If the problem persists, replace the NTC3 sensor</p>
E844	Internal error	<p>If the problem persists after two RESET attempts, replace the MCBA.</p>
E852	Flue gas temperature too high (NTC5)	<ul style="list-style-type: none"> - Check the connection of the NTC5 sensor - Check the wiring of the NTC5 sensor <p>If the problem persists, replace the NTC5 sensor</p>
E860	Error while reading the parameters	<p>Press RESET</p> <p>If the error persists, replace the MCBA.</p>
E865	Problem with the power supply to the fan	<ul style="list-style-type: none"> - Check the MCBA power supply voltage. <p>If it is OK, replace the fan.</p>



A series of horizontal dotted lines for writing, spanning the width of the page.



N°	EN	FR	NL	ES	IT	DE
01	Horizontal outlet	Terminal horizontal	Muurdoorvoer	Terminal horizontal	Tereminale orizzontale	Waagerechte Wanddurchführung
02	Vertical outlet	Terminal vertical	Dakdoorvoer	Terminal vertical	Terminale verticale	Senkrechte Dachdurchführung
03	Flue pipe L 250 mm	Conduite L 250 mm	Rookgaspijp L 250 mm	Tubo L 250 mm	Prolunga L 250 mm	Rohr L 250 mm
04	Flue pipe L 500 mm	Conduite L 500 mm	Rookgaspijp L 500 mm	Tubo L 500 mm	Prolunga L 500 mm	Rohr L 500 mm
05	Flue pipe L 1000 mm	Conduite L 1000 mm	Rookgaspijp L 1000 mm	Tubo L 1000 mm	Prolunga L 1000 mm	Rohr L 1000 mm
06	Adjustable flue pipe L 500 mm adjustable L 235 - 400 mm	Conduite L 500 mm réglable L 325 - 400 mm	Regelbare rookgaspijp L 500 mm instelbaar L 235 - 400 mm	Tubo L 500 mm regulable L 325 - 400 mm	Prolunga L 500 mm regolabile L 325 - 400 mm	Verstellbares Rohr L 500 mm einstellbar L 325 - 400 mm
07	Flue bend 45°	Coude 45°	Bocht 45°	Codo 45°	Curva 45°	Bogen 45°
08	Flue bend 90°	Coude 90°	Bocht 90°	Codo 90°	Curva 90°	Bogen 90°
09	Condensate recovery	Récupérateur de condensats	Condensopvang	Recuperador de condensados	Recuperatore di condensati	Kondensatsammler
10	Measuring element	Tube de mesure	Meetelement	Tubo de medida	Elemento di misura	Messelement
11	Parallel connection adapter	Adaptateur de raccordement en parallèle	Parallel aansluitingsadapter	Adaptador de conexión paralelo	Adattatore di collegamento in parallelo	Paralleler Verbindungsadapter
12	Adjustable flashing	Solin réglable	Regelbare losse pan	Te adaptador para chimenea desdoblada	Tegola regolabile	Bleidachpfanne
13	Flat roof flashing	Solin toit plat	Losse pan plat dak	Cubreaguas chimenea	Tegola a tetto piatta	Flachdachflansch
14	Bracket Ø 125 mm	Attache de fixation Ø 125 mm	Bevestiging Ø 125 mm	Brida fijación Ø 125 mm	Supporto di fissazione Ø 125 mm	Befestigung Ø 125 mm



01 : 537D6185



10 : 537D6193



06 : 537D6189



11 : 537D6232



02 : 537D6184



07 : 537D6190



12 : 537D6195

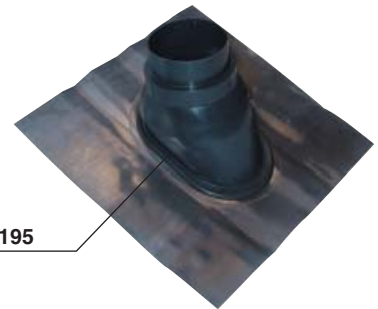

03 : 537D6186
04 : 537D6187
05 : 537D6188



08 : 537D6191



13 : 537D6194







09 : 537D6192

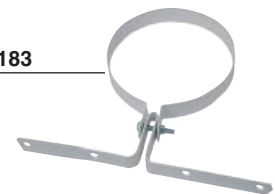

14 : 537D6183



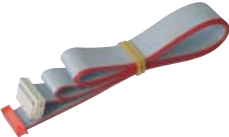

 5476G008	■ Prestige Solo	EN : NTC sensor [5 x 18 = 12 kΩ] FR : Sonde NTC [5 x 18 = 12 kΩ]
	■ Prestige AquaSpeed	NL : NTC voeler [5 x 18 = 12 kΩ] ES : Sonda NTC [5 x 18 = 12 kΩ]
	■ Prestige Excellence	IT : Sonda NTC [5 x 18 = 12 kΩ] DE : NTC-Fühler [5 x 18 = 12 kΩ]
 547D3018	Prestige Solo	EN : DHW NTC sensor - 12 kΩ FR : Sonde NTC sanitaire - 12 kΩ
	Prestige AquaSpeed	NL : NTC voeler sanitair - 12 kΩ ES : Sonda NTC sanitaria - 12 kΩ
	■ Prestige Excellence	IT : Sonda NTC sanitaria - 12 kΩ DE : NTC- Brauchwasserfühler - 12 kΩ
 257F1071	■ Prestige Solo	EN : Ionisation and ignition cable FR : Câble d'ionisation et d'allumage
	■ Prestige AquaSpeed	NL : Ontsteek / ionisatie kabel ES : Cable de ionización y encendido
	■ Prestige Excellence	IT : Cavo di accensione e d'ionizzazione DE : Ionisations- und Zündungskabel
 537D3039	■ Prestige Solo	EN : Rectifier [24 Volt] FR : Câble rectificateur [24 Volt]
	■ Prestige AquaSpeed	NL : Gelijkrichter [24 Volt] ES : Cable rectificador [24 Volt]
	■ Prestige Excellence	IT : Cavo rettificatore [24 volt] DE : Gleichrichter [24 Volt]
 257F1079	■ Prestige Solo	EN : Flat cable FR : Câble plat
	■ Prestige AquaSpeed	NL : Kabel display ES : Cable plano
	■ Prestige Excellence	IT : Cavo piatto DE : Kabel display







 <p>547D3021</p>	<p>Prestige Solo</p>	<p>EN : Transformer [230 Volt / 24 Volt]</p>
	<p>Prestige AquaSpeed</p>	<p>FR : Transformateur [230 Volt / 24 Volt]</p>
	<p>Prestige Excellence</p>	<p>NL : Transformator [230 Volt / 24 Volt]</p> <p>ES : Transformador [230 Volt / 24 Volt]</p> <p>IT : Trasformatore [230 Volt / 24 Volt]</p> <p>DE : Transformator [230 Volt / 24 Volt]</p>
 <p>537D3020</p>	<p>Prestige Solo</p>	<p>EN : Display board</p> <p>FR : Platine display</p>
	<p>Prestige AquaSpeed</p>	<p>NL : Display</p> <p>ES : Display</p>
	<p>Prestige Excellence</p>	<p>IT : Scheda display</p> <p>DE : Display</p>
 <p>54763010</p>	<p>Prestige Solo</p>	<p>EN : Pressure gauge [0 - 4 bars]</p> <p>FR : Manomètre [0 - 4 bars]</p>
	<p>Prestige AquaSpeed</p>	<p>NL : Manometer [0 - 4 bar]</p> <p>ES : Manómetro [0 - 4 bares]</p>
	<p>Prestige Excellence</p>	<p>IT : Manometro [0 - 4 bar]</p> <p>DE : Manometer [0 - 4 bar]</p>
 <p>54766016</p>	<p>Prestige Solo</p>	<p>EN : ON / OFF switch</p> <p>FR : Interrupteur général</p>
	<p>Prestige AquaSpeed</p>	<p>NL : Hoofdschakelaar</p> <p>ES : Interruptor general</p>
	<p>Prestige Excellence</p>	<p>IT : Interruttore generale</p> <p>DE : An / Aus Schalter</p>
 <p>497B0025</p>	<p>Prestige Solo</p>	<p>EN : Air inlet tube to venturi</p> <p>FR : Tube d'entrée d'air venturi</p>
	<p>Prestige AquaSpeed</p>	<p>NL : Inlaatbuis venturi</p> <p>ES : Tubo de entrada de aire venturi</p>
	<p>Prestige Excellence</p>	<p>IT : Tubo d'ingresso dell'aria nel venturi</p> <p>DE : Eintrittrohr Venturi</p>



 <p>557D3011</p>	■ Prestige Solo	EN : Water pressure safety switch FR : Pressostat de sécurité manque d'eau
	■ Prestige AquaSpeed	NL : Waterdruk schakelaar ES : Presostato falta de agua
	■ Prestige Excellence	IT : Pressostato di sicurezza mancanza d'acqua DE : Wassermangelsicherung
 <p>55426017</p>	■ Prestige Solo	EN : Safety valve [3 bars / Ø 1/2" - Ø 3/4"] FR : Soupape de sécurité [3 bars / Ø 1/2" - Ø 3/4"]
	■ Prestige AquaSpeed	NL : Veiligheidsventil [3 bar / Ø 1/2" - Ø 3/4"] ES : Válvula de seguridad [3 bares / Ø 1/2" - Ø 3/4"]
	■ Prestige Excellence	IT : Valvola di sicurezza [3 bar / Ø 1/2" - Ø 3/4"] DE : Sicherheitsventil [3 bar / Ø 1/2" - Ø 3/4"]
 <p>55445006</p>	Prestige Solo	EN : Manual air vent [Ø 3/4"] FR : Purgeur manuel [Ø 3/4"]
	Prestige AquaSpeed	NL : Manuele ontluchter [Ø 3/4"] ES : Purgador manual [Ø 3/4"]
	■ Prestige Excellence	IT : Valvola di spuro manuele [Ø 3/4"] DE : Manueller Entlüfter [Ø 3/4"]
 <p>55445007</p>	Prestige Solo	EN : Automatic air vent FR : Purgeur automatique
	■ Prestige AquaSpeed	NL : Automatische ontluchter ES : Valvola di spurgo automatico
	Prestige Excellence	IT : Purgeur automatico DE : Automatischer Entlüfter
 <p>55426001</p>	■ Prestige Solo	EN : Drain cock valve [Ø 1/2"] FR : Robinet de vidange [Ø 1/2"]
	■ Prestige AquaSpeed	NL : Leegloopkraan [Ø 1/2"] ES : Grifo de vaciado [Ø 1/2"]
	■ Prestige Excellence	IT : Valvola di scarico [Ø 1/2"] DE : Entleerungshahn [Ø 1/2"]



 557A6006	 Prestige Solo	EN : Non return valve FR : Clapet anti-retour
	 Prestige AquaSpeed	NL : Terugslagklep ES : Válvula anti-retorno
	 Prestige Excellence	IT : Valvola di ritegno DE : Rückschlagventil
		EN : MCBA burner control FR : Module de contrôle MCBA NL : Brander module MCBA ES : Módulo de control MCBA IT : Centralina MCBA DE : MCBA- Brennersteuerung
	5476G014	Prestige AquaSpeed 24 kW
	5476G015	Prestige Excellence 24 kW
	5476G016	Prestige Solo 24 kW
	5476G017	Prestige AquaSpeed 24 kW [<i>Propane - Propane - Propaan - Propano - Propano - Propangas</i>]
5476G018	Prestige Excellence 24 kW [<i>Propane - Propane - Propaan - Propano - Propano - Propangas</i>]	
5476G019	Prestige Solo 24 kW [<i>Propane - Propane - Propaan - Propano - Propano - Propangas</i>]	
5476G020	Prestige AquaSpeed 32 kW	
5476G021	Prestige Excellence 32 kW	
5476G022	Prestige Solo 32 kW	
5476G023	Prestige AquaSpeed 32 kW [<i>Propane - Propane - Propaan - Propano - Propano - Propangas</i>]	
5476G024	Prestige Excellence 32 kW [<i>Propane - Propane - Propaan - Propano - Propano - Propangas</i>]	
5476G025	Prestige Solo 32 kW [<i>Propane - Propane - Propaan - Propano - Propano - Propangas</i>]	



N°	EN	FR	NL	ES	IT	DE
A01	Side panel	Latérale	Zijkanten	Lateral	Laterale	Seitenblech
A02	Front panel	Face avant	Frontstuk	Parte delantero	Pannello anteriore	Vorderblech
A03	Top cover	Couvercle supérieur	Bovenkap	Tapa superior	Coperchio superiore	Obere Abdeckung
A04	Rear panel	Panneau arrière	Achterpaneel	Panel trasero	Pannello posteriore	Hinterblech
A05	Control panel [ABS]	Tableau [ABS]	Paneel [ABS]	Panel [ABS]	Pannello [ABS]	ABS-Tafel
A06	Wall mounting	Fixation murale	Wandbevestiging	Fijación mural	Fissaggio murale	Wandhalterung
A07	Control panel attachment left	Tableau prolongement gauche	Paneel verlengstuk links	Elemento izquierdo del panel	Elemento sinistro del pannello	ABS-Tafel Verlängerung links
A08	Control panel attachment right	Tableau prolongement droite	Paneel verlengstuk rechts	Elemento derecho del panel	Elemento destro del pannello	ABS-Tafel Verlängerung rechts
A09	Back cover plate display	Protection arrière du display	Afschermplaat display achter	Protección posterior del display	Protezione posteriore del display	Abschirmung hinter display
A10	Bottom panel	Jaquette inférieure	Onderpaneel	Panel inferior	Pannello inferiore	Unterblech
A11	Expansion vessel support	Support vase d'expansion	Steun expansievat	Apoyo vaso de expansión	Appoggio vaso di espansione	Träger Ausdehnungsgefäß



Prestige Solo / AquaSpeed

A01 : 21471419

A03 : 21475419

A06 : 21480069

A04 : 21474419

A02 : 21473419

A01 : 21471419

A05 : 54761008

A09 : 2147E419

A10 : 21476419

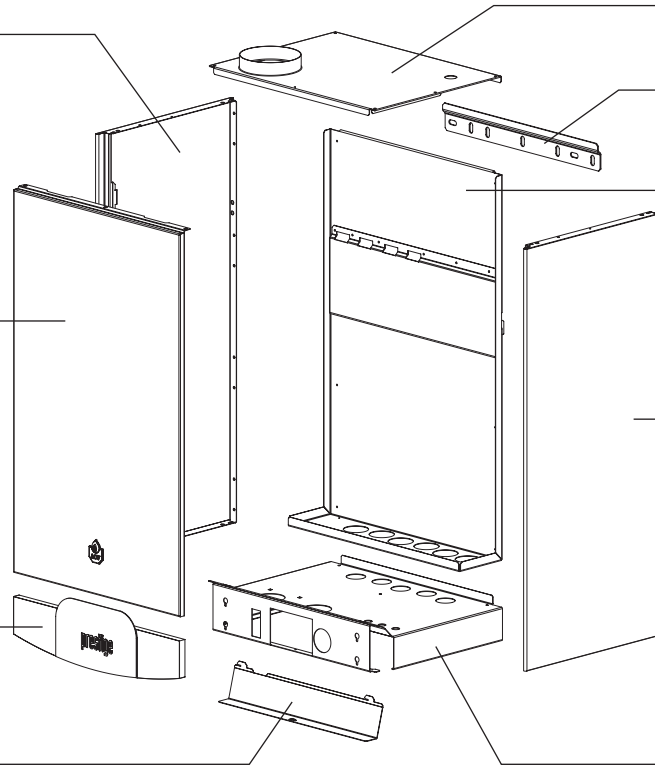

Prestige Excellence

A01 : 21471420

A03 : 21475420

A06 : 21480069

A04 : 21474420

A02 : 21473420

A01 : 21471420

A07 : 497B6002

A05 : 54761008

A11 : 2247F420

A08 : 497B6003

A09 : 2147E420

A10 : 21476420

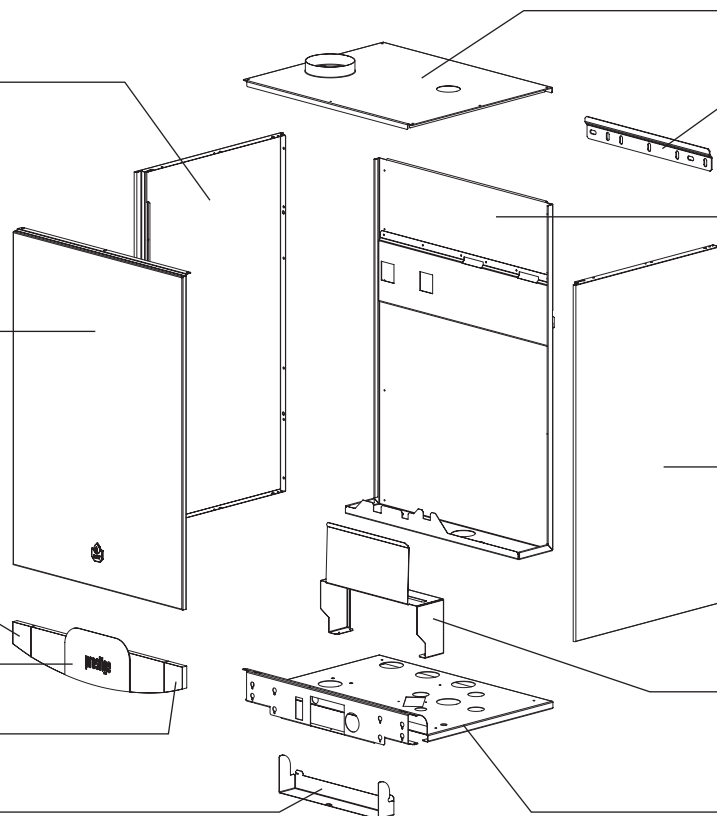



N°	EN	FR	NL	ES	IT	DE
B01	Flue gas pipe Ø 80mm	Tube de fumées Ø 80mm	Rookgas pijp Ø 80mm	Tubo de humos Ø 80mm	Condotto fumi Ø 80 mm	Abgasrohr Ø 80mm
B02	Heat exchanger	Echangeur de chaleur	Warmtewisselaar	Intercambiador de calor	Scambiatore di calore	Wärmetauscher
B03	Exchanger flow pipe	Tube de départ de l'échangeur	Aanvoerleiding warmtewisselaar	Tubo de salida del intercambiador de calor	Tubo di mandata da lo scambiatore	Vorlaufrohr Wärmetauscher
B04	Heating circulator 1" - L 130 mm	Circulateur chauffage 1" - L 130 mm	Verwarming circulator 1" - L 130 mm	Circulador de calefacción 1" - L 130 mm	Circolatore riscaldamento 1" - L 130 mm	Heizungspumpe 1" - L 130 mm
B05	Heating circulator flow pipe	Tube départ du circulateur chauffage	Verktrek Verwarming circulator pijp	Tubo de salida del circulator de calefacción	Tubo di mandata da lo circolatore riscaldamento	Vorlaufrohr Heizungspumpe
B06	Condensstrap 5/4" - L 300 mm	Siphon 5/4" L 300 mm	Syfon 5/4" L 300 mm	Sifón 5/4" L 300 mm	Sifone 5/4" L 300 mm	Siphon 5/4" L 300 mm
B07	Gas pipe	Tube gaz	Gas pijp	Tubo gas	Tubo gas	Gasrohr
B08	Domestic hot water Tank	Préparateur ou mini-préparateur ECS	Sanitair warm water boiler	Acumulador de agua caliente sanitaria	Bollitore d'acqua calda sanitaria	Brauchwasserbereiter
B09	DHW pump connection pipe	Tube de raccordement circulateur ECS	Aansluiting pijp sanitair circulator	Tubo de conexión del circulator sanitario	Tubo di collegamento del circolatore sanitario	Verbindungsrohr Warm Wasser Lade pumpe
B10	DHW loading pump 1" - L 130 mm	Circulateur ECS 1" - L 130 mm	Sanitaire circulator 1" - L 130 mm	Circulador sanitario 1" - L 130 mm	Circolatore sanitario 1" - L 130 mm	Warm Wasser Lade pumpe 1" - L 130 mm
B11	DHW circulator outlet pipe	Tube départ circulateur ECS	Uitgang pijp sanitair circulator	Tubo de salida del circulator sanitario	Tubo di mandata da lo circolatore sanitario	Vorlaufrohr Warm Wasser Lade pumpe
B12	Heating return pipe	Tube retour chauffage	Terugvoer verwarming pijp	Tubo retorno de calefacción	Tubo di ritorno riscaldamento	Heizungsruchlaufrohr
B13	Domestic cold water inlet pipe	Tube d'entrée eau froide sanitaire	Koudwateraanvoer pijp	Tubo de llegada de agua fría sanitaria	Tubo d'ingresso acqua fredda sanitaria	Kalteswasser Eintrittsrohr
B14	Domestic hot water outlet pipe	Tube départ ECS	Uitgang sanitair warm water pijp	Tubo salida de agua caliente sanitaria	Tubo di mandata acqua calda sanitaria	Warm Wasserrohr
B15	Expansion vessel	Vase d'expansion	Expansievat	Vaso de expansión	Vaso di espansione	Ausdehnungsgefäß
B16	"T" connection of DHW Tank	Raccord en T du préparateur ECS	"T" aansluiting sanitair warm water boiler	Conexión en "T" del acumulador	Collegamento "T" del bollitore	T-Verbindungsstück Speicher



Prestige Solo / AquaSpeed

B01 : 497B0031

B07 : 507F4083

B03 : 507F4086

B08 : 507F4035

B02 : 63962009

B09 : 507F4088

B04 : 557A4014

B10 : 557A4014

B05 : 507F4087

B11 : 507F4089

B12 : 507F4052

B13 : 507F4053

B06 : 557B4002

B14 : 507F4054

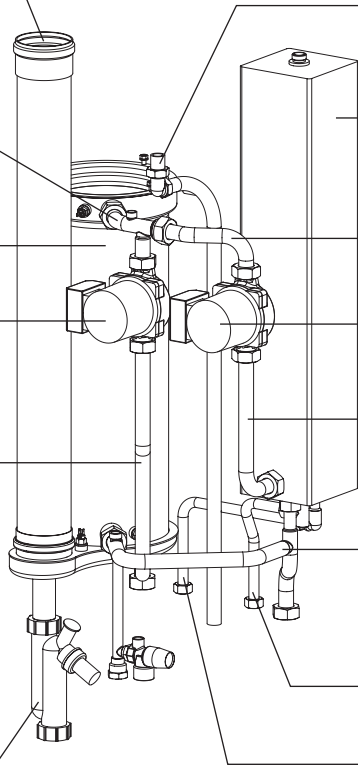

Prestige Excellence

B01 : 497B0031

B11 : 507F4068

B10 : 557A4017

B16 : 507F4066

B04 : 557A4014

B08 : 30538481

B02 : 63962009

B03 : 507F4069

B05 : 507F4070

B15 : 557A7008

B12 : 507F4071

B06 : 557B4002

B16 : 507F4066

B07 : 507F4055

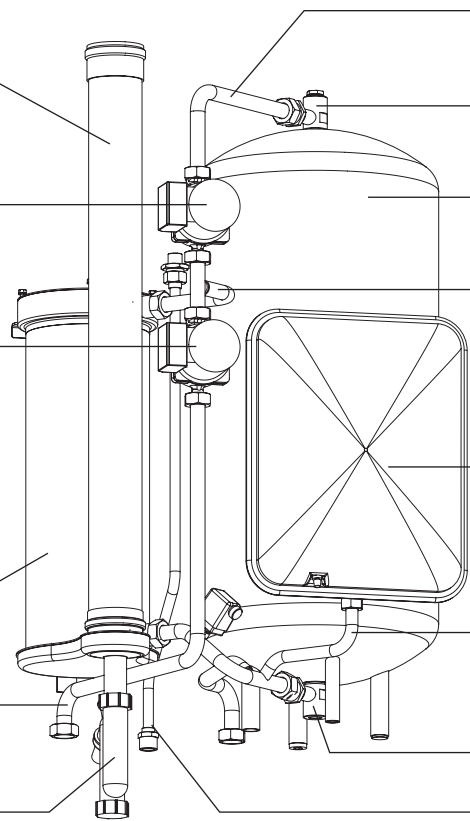



N°	EN	FR	NL	ES	IT	DE
C01	Venturi + seal	Venturi + joint	Venturi + dichting	Venturi + junta	Venturi + Guarnizione	Venturi + dichtung
C02	Fan	Ventilateur	Ventilator	Ventilador	Ventilatore	Geblüse
C03	Silicone seal fan	Joint silicone ventilateur	Siliconedichting ventilator	Junta de silicona ventilador	Guarnizione silicone del ventilatore	Silikonichtung Gebläse
C04	Ignition electrode	Electrode d'allumage	Ontstekingselectrode	Electrodo de encendido	Elettrodo di accensione	Zündelectrode
C05	Electrode seal	Joint électrode	Dichting electrode	Junta de electrodo	Guarnizione elettrodo	Dichtung Elektrode
C06	Burner rod seal	Joint rampe brûleur	Dichting branderstaaf	Junta de rampa quemador	Guarnizione rampa bruciatore	Dichtung Brennerlanze
C07	Burner flange insulation	Isolation plaque brûleur	Dichting branderflens	Aislamiento placa quemador	Isolamento piastra bruciatore	Isolierung Brennerflansch
C08	Burner seal Ø 210 mm	Joint brûleur Ø 210 mm	Branderdichting Ø 210 mm	Junta de quemador Ø 210 mm	Guarnizione bruciatore Ø 210	Brennerdichtung Ø 210 mm
C09	Burner rod	Rampe brûleur	Branderstaaf	Rampa quemador	Rampa bruciatore	Brennerlanze
C10	Burner flange	Plaque brûleur	Branderflens	Placa quemador	Piastra bruciatore	Brennerflansch
C11	Flame inspection window	Regard de flamme	Vlamcontrole	Tapa de llama	Spioncino fiamma	Schauloch Flamme
C12	Gas valve flange Ø 1/2"	Bride vanne gaz Ø 1/2"	Gasklepfens Ø 1/2"	Brida de válvula de gas Ø 1/2"	Piastra valvola gas Ø 1/2"	Flansh Gasventil Ø 1/2"
C13	Orifice Ø 52 mm	Opercule Ø 52 mm	Diafragma Ø 52 mm	Diafragma Ø 52 mm	Diaframma Ø 52 mm	Diafragma Ø 52 mm
C14	Gas valve	Vanne gaz	Gasklep	Válvula de gas	Valvola gas	Gasventil
C15	Venturi O-ring	O-ring venturi	O-ring venturi	Anillo venturi	Anello venturi	O-Ring venturi

